

IR BULLET IP CAMERA SERIES

OPERATION GUIDE

Please read instructions thoroughly before operation and retain it for future reference.

IMPORTANT SAFEGUARD



All lead-free products offered by the company comply with the requirements of the European law on the Restriction of Hazardous Substances (RoHS) directive, which means our manufacture processes and products are strictly "lead-free" and without the hazardous substances cited in the directive.



The crossed-out wheeled bin mark symbolizes that within the European Union the product must be collected separately at the product end-of-life. This applies to your product and any peripherals marked with this symbol. Do not dispose of these products as unsorted municipal waste. Contact your local dealer for procedures for recycling this equipment.



This is a class A product. In a domestic environment this product may cause radio interference in which case the user may be required to take adequate measures.

Federal Communications Commission Interference Statement

This equipment has been tested and found to comply with the limits for a Class A digital device, pursuant to Part 15 of the FCC Rules. These limits are designed to provide reasonable protection against harmful interference when the equipment is operated in a commercial environment. This equipment generates, uses, and can radiate radio frequency energy and, if not installed and used in accordance with the instruction manual, may cause harmful interference to radio communications. Operation of this equipment in a residential area is likely to cause harmful interference in which case the user will be required to correct the interference at his own expense.

This device complies with Part 15 of the FCC Rules. Operation is subject to the following two conditions:

- (1) This device must not cause harmful interference, and
- (2) This device must accept any interference received, including interference that may cause undesired operation.

Trademark Acknowledgements

iPad® & iPhone® are the registered trademarks of Apple Inc.

Android™ is a trademark of Google Inc. Use of this trademark is subject to Google Permissions.

Microsoft®, Windows® & Internet Explorer® are registered trademarks of Microsoft Corporation in the United States and/or other countries.

Disclaimer

We reserve the right to revise or remove any content in this manual at any time. We do not warrant or assume any legal liability or responsibility for the accuracy, completeness, or usefulness of this manual. The content of this manual is subject to change without notice.

This product doesn't have a standby / off mode.

MPEG4 Licensing

THIS PRODUCT IS LICENSED UNDER THE MPEG4 VISUAL PATENT PORTFOLIO LICENSE FOR THE PERSONAL AND NON-COMMERCIAL USE OF A CONSUMER FOR (i) ENCODING VIDEO IN COMPLIANCE WITH THE MPEG4 VISUAL STANDARD ("MPEG-4 VIDEO") AND/OR (ii) DECODING MPEG4 VIDEO THAT WAS ENCODED BY A CONSUMER ENGAGED IN A PERSONAL AND NON-COMMERCIAL ACTIVITY AND/OR WAS OBTAINED FROM A VIDEO PROVIDER LICENSED BY MPEG LA TO PROVIDE MPEG4 VIDEO. NO LICENSE IS GRANTED OR SHALL BE IMPLIED FOR ANY OTHER USE. ADDITIONAL INFORMATION INCLUDING THAT RELATING TO PROMOTIONAL INTERNAL AND COMMERCIAL USES AND LICENSING MAY BE OBTAINED FROM MPEG LA, LLC. SEE [HTTP://WWW.MPEGLA.COM](http://www.mpegla.com).

GPL Licensing



This product contains codes which are developed by Third-Party-Companies and which are subject to the GNU General Public License ("GPL") or the GNU Lesser Public License ("LGPL").

The GPL Code used in this product is released without warranty and is subject to the copyright of the corresponding author.

Further source codes which are subject to the GPL-licenses are available upon request.

We are pleased to provide our modifications to the Linux Kernel, as well as a few new commands, and some tools to get you into the code. The codes are provided on the FTP site, and please download them from the following site or you can refer to your distributor:

Model 1, 2, 3 & 4: <http://download.dvrtw.com.tw/GPL/IPCAM/F-Series/linux.tar.gz>

Model 5: <http://download.dvrtw.com.tw/GPL/IPCAM/A-Series/linux.tar.gz>

Model 6 & 7: <http://download.dvrtw.com.tw/GPL/IPCAM/S-Series/linux.tar.gz>

TABLE OF CONTENTS

1. OVERVIEW.....	1
1.1 Product Features.....	1
1.2 Package Content.....	1
1.3 Cable Overview.....	1
1.4 External Alarm Connection.....	2
2. CAMERA ACCESS WITH INTERNET EXPLORER.....	3
2.1 Camera Login.....	3
2.2 Control Panel Overview.....	3
2.3 Digital PTZ (DPTZ) Operations.....	5
2.4 Event Record Search & Playback.....	7
3. CAMERA CONFIGURATIONS.....	8
3.1 System configuration menu.....	8
3.2 Network.....	10
3.2.1 Network.....	10
3.2.2 QoS.....	10
3.2.3 DDNS.....	10
3.2.4 SNTP.....	10
3.2.5 FTP.....	11
3.2.6 MAIL.....	11
3.2.7 SMS.....	12
3.2.8 Filter.....	13
3.2.9 UPnP / Bonjour.....	13
3.2.10 RTP.....	14
3.2.11 SNMP.....	15
3.2.12 IEEE 802.1X (For selected models only).....	16
3.2.13 Network Share.....	17
3.2.14 Network Failure Detection.....	17
3.3 Camera.....	17
3.3.1 Camera.....	17
3.3.2 Video.....	18
3.3.3 ROI (For selected models only).....	18
3.3.4 Color.....	18
3.3.5 Audio.....	19
3.3.6 Advanced.....	19
3.3.7 Privacy Mask (For selected models only).....	20
3.4 VA (For selected models only).....	21
3.4.1 TA.....	21
3.5 Record.....	21
3.5.1 Record.....	21
3.5.2 Record Timer.....	21
3.6 Storage.....	22
3.6.1 Memory.....	22
3.7 Trigger.....	22
3.7.1 Trigger.....	22
3.7.2 Snapshot.....	24
3.8 General.....	24
3.8.1 General.....	24
3.8.2 Time.....	25
3.8.3 Server Log.....	25
3.8.4 Online.....	26
3.8.5 Account.....	26
3.8.6 Google Maps.....	27
3.8.7 Maintenance.....	27
APPENDIX 1 PRODUCT SPECIFICATIONS.....	29

APPENDIX 2 BIT RATE TABLE FOR REFERENCE	30
APPENDIX 3 POE CONNECTION	32
APPENDIX 4 API ID APPLICATION FOR SMS MESSAGING.....	33
APPENDIX 5 Q&A	35
APPENDIX 6 RECORDING TIME TABLE	36
APPENDIX 7 PREREQUISITES FOR NETWORK SHARE.....	37
A7.1 Check PC IP Address	37
A7.2 Create "Administrator" Account.....	37
A7.3 Share Folder	38

1. OVERVIEW

1.1 Product Features

- Easy **network setup** with your **iOS / Android OS**
- **ONVIF** standard supported to simplify system integration
- **POE (Power-over-Ethernet)** support to eliminate the use of power cables and reduce installation costs
- IR LEDs built-in for **night surveillance**
- **External alarm I/O device** connection
- **Line in / out** jacks available for audio transmission
- **DWDR** to increase image recognizability in overexposure and dark areas.
- **Remote Surveillance**
 - **Full compatibility** with **iOS & Android OS**, and **Internet Explorer** on Windows operating system

1.2 Package Content

➤ Standard Package

- | | |
|------------------------------------|--------------------------------------|
| <input type="checkbox"/> IR Camera | <input type="checkbox"/> Quick Guide |
|------------------------------------|--------------------------------------|

➤ Optional Accessories

- | | |
|---|---|
| <input type="checkbox"/> Screws & wall plugs | <input type="checkbox"/> CD manual |
| <input type="checkbox"/> Sun shield | <input type="checkbox"/> screw for sun shield |
| <input type="checkbox"/> Installation sticker | <input type="checkbox"/> Waterproof kit |
| <input type="checkbox"/> Wrench | |

1.3 Cable Overview

Cable	Description
Power cable	Connect to DC12V power supply. Note: The power adapter is optional.
RJ45 network cable	Connect it to the supplied RJ45 cable extender adapter for cable extension, and prepare another RJ45 network cable with suitable length for your connection.
GND	Ground wire, used for reset default or external device connection.
Alarm-in	Reserved for connecting to an external alarm device. For details, please refer the user manual of your alarm device.
Alarm-out	Reserved for connecting to an external alarm device. For details, please refer the user manual of your alarm device.
RESET	Remove the insulating coating of this wire, and twist it with a ground wire together to reset default. This will reset all parameters, including the IP address to factory default settings. Note: Disconnect power before twisting these two wires together, and connect to power again for reset default.
Line in (Blue)	Support microphone connection.
Line out (Green)	Support speaker connection.

1.4 External Alarm Connection

This camera supports external I/O device connection for easy connection.

Below shows you how to connect an external device to this camera.

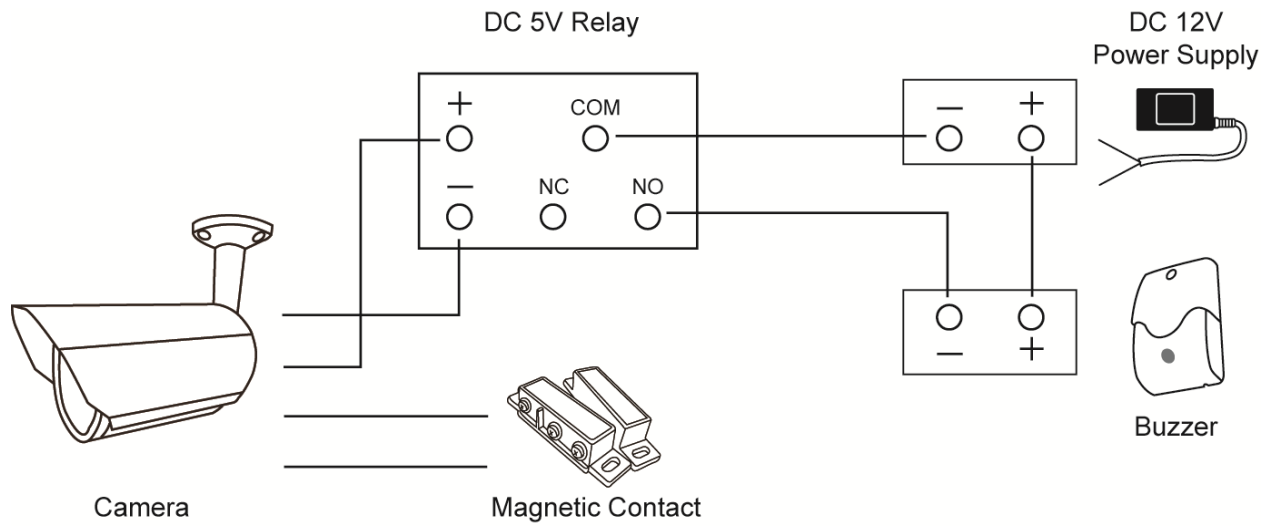

2. CAMERA ACCESS WITH INTERNET EXPLORER

This network camera can be accessed via Microsoft Internet Explorer and iOS / Android mobile devices with our self-developed program “EagleEyes” installed depending on different using situations.

Before using the camera, make sure you have configured the network settings, and the network connection is fine.

For network configurations, please refer to:

- “**ADVANCED NETWORK SETUP**” downloadable from www.surveillance-download.com/user/m650.swf.

2.1 Camera Login

Step1: Open your web browser, and key in <http://ipaddress:portnum> in the URL address box.

For example, for the IP address 60.121.46.236 and port No. 888, please key in “<http://60.121.46.236:888>” into the URL address box, and press “Enter”.

Step2: In the login page, key in the user name and password, and enter the security code from the image below if any. Then, click “LOGIN”.

Step3: The wizard is then started.

- To skip the wizard and directly access the camera live view, click “Close”.
- To directly access the camera live view without starting the wizard for the login next time, check “Do not start wizard at login”.









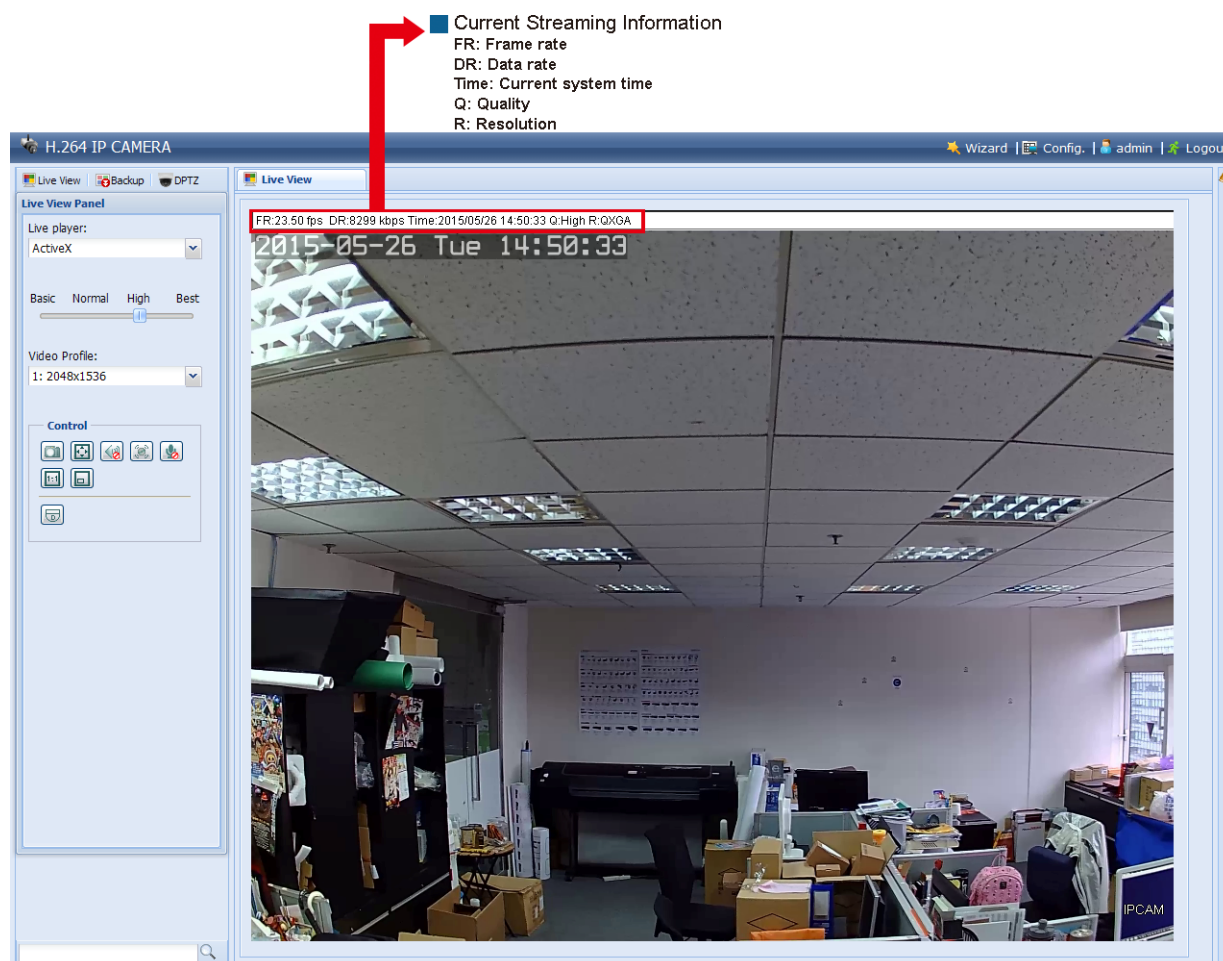





Note: If you’re prompted to install “VLC player”, “Software” and “H264 Streaming Viewer”, please agree to proceed the installation.

Step5: When the login is successful, the live view is shown.

2.2 Control Panel Overview

Note: The buttons available depend on the device you have and the user level used to log in.



Function	Icon	User Level	Description
Live		Supervisor / Power User / Normal User / Guest	Switch to the live view page.
Backup		Supervisor / Power User	Enter the event record list for video playback. For details, please refer to "2.4 Event Record Search & Playback" at page 6.
DPTZ		Supervisor / Power User / Normal User	Switch to the DPTZ configuration page. For details, please refer to "2.3 Digital PTZ (DPTZ) Operations" at page 4.
Config.		Supervisor / Power User	Switch to the system configuration page, and the functions available for "Supervisor" and "Power User" are different. For details, please refer to "3.1 System configuration menu" at page 8.
Live player	--	Supervisor / Power User / Normal User / Guest	Select the image player from the drop-down list: <ul style="list-style-type: none"> ■ ActiveX ■ QuickTime QuickTime is Apple Inc.'s multimedia software. You need to have QuickTime installed in your operating system before selecting "QuickTime". When it is selected, you will be promoted to enter the user name and password to access the camera. ■ VLC
Quality	--	Supervisor / Power User / Normal User	Click & drag the slider to select the video quality: BASIC / NORMAL / HIGH / BEST.
Video Profile	--	Supervisor / Power User / Normal User	Select the pre-defined video set from the drop list. The video set could be configured in "Config" -> "Camera" -> "Video".
Snapshot		Supervisor / Power User / Normal User	Click to take a snapshot of the current view on a new window. Right click on the picture and re-save it to the location you want.
Live View Size:		Supervisor / Power User / Normal User	
Full Screen			Click to display the image in full screen. To exit the full screen mode, press "Esc" on your keyboard. <i>This icon appears only when the selected resolution is 640 x 480 or above.</i>
Double size			The QVGA resolution is resized to fit into the current live view size. <i>This icon appears only when the selected resolution is 320 x 240.</i>
Normal Size			The current live view size is the same as the selected resolution. <i>This icon appears only when the selected resolution is 1280 x 720 or above.</i>
Fit to screen			The selected resolution is resized to fit into the current live view size. <i>This icon appears only when the selected resolution is 1280 x 720 or above.</i>
No Scale			Click and hold the movable square on the left bottom corner of the live view to move <i>This icon appears only when the selected resolution is 1280 x 720 or above.</i>
Audio On / Off		Supervisor / Power User / Normal User	Click to switch the audio-in on / off.
Alarm Out		Supervisor / Power User / Normal User	Click to force your alarm-out device to work. For example, when your alarm device is a buzzer, click this button and your buzzer will start to sound even if there's no alarm event.
Microphone		Supervisor	Click to switch the audio-out on / off.
DPTZ*		Supervisor / Power User / Normal User	Click to enable the zoom-in / out function. To move the image in the zoom-in mode, simply click on where you want to see in the live view. <i>For vari-focal models only.</i>

* For selected models only

2.3 Digital PTZ (DPTZ) Operations

This camera has PTZ capability, i.e. digital PTZ (hereafter called “DPTZ”), for wide area monitoring.

STEP1: Click “DPTZ” to show the DPTZ control panel.

➤ Type1

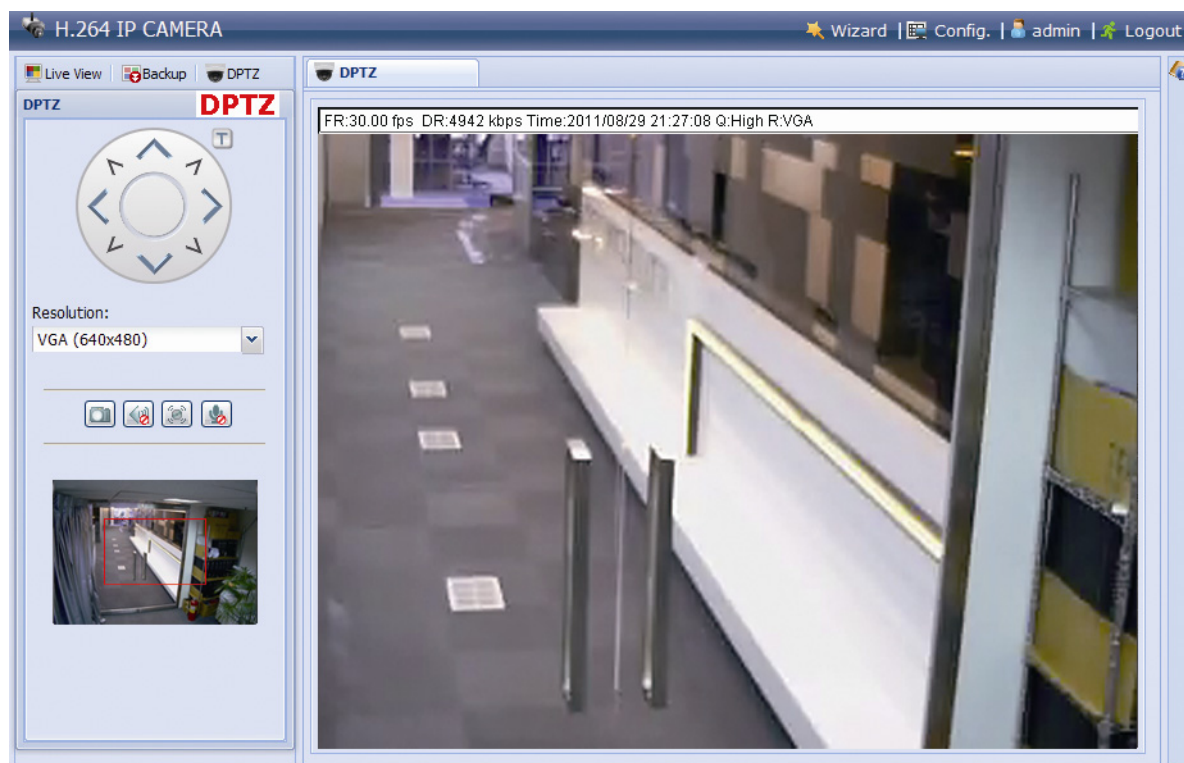







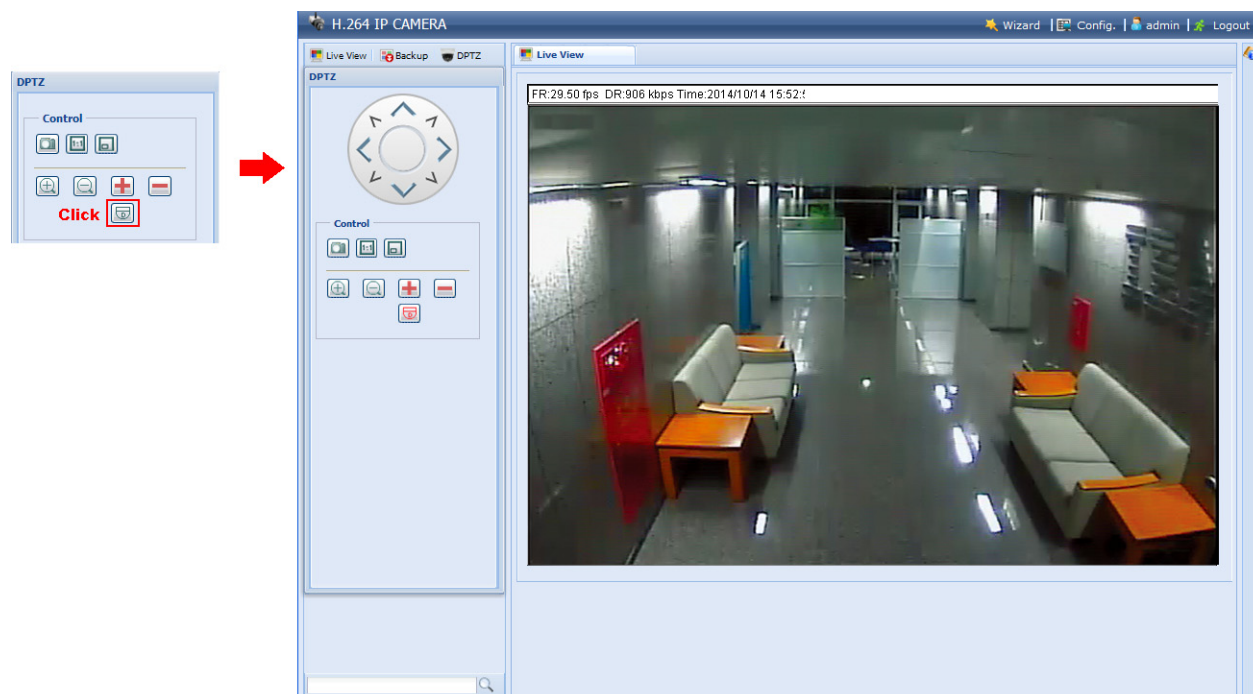





STEP2: Select the functions when needed:

FUNCTION	ICON	DESCRIPTION
Moving panel	--	Move the picture.
Resolution	--	Select the video resolution for the DPTZ function. Only “VGA” and “QVGA” are available.
Take snapshots		Click to take a snapshot of the current view on a new window. Right click on the picture and re-save it to the location you want.
Alarm Out		Click to force your alarm-out device to work. For example, when your alarm device is a buzzer, click this button and your buzzer will start to sound even if there’s no alarm event.
Audio On / Off		Click to switch the audio-in on / off.
Microphone*		Click to switch the audio-out on / off.

➤ Type 2









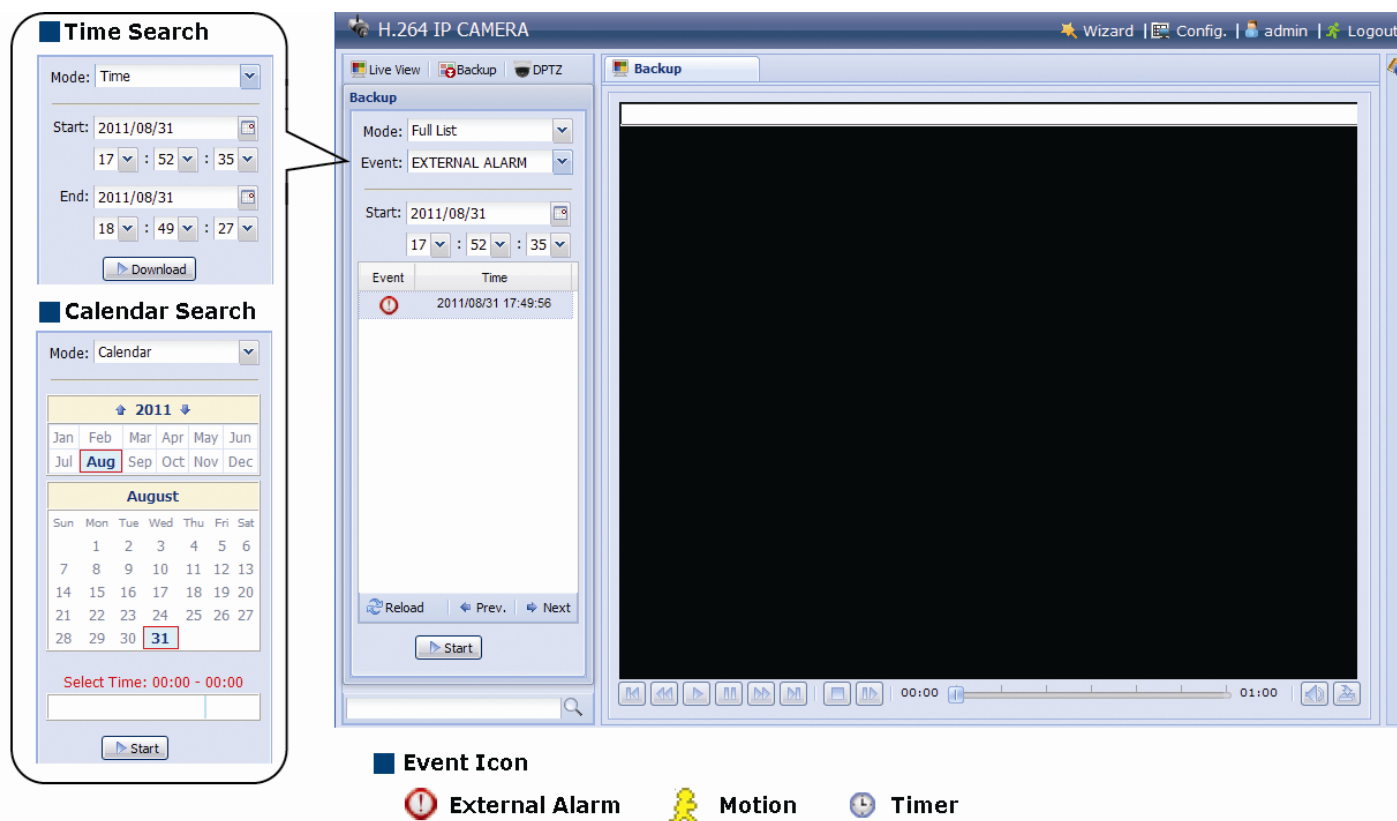

FUNCTION	ICON	DESCRIPTION
Moving panel	--	When  is selected, the moving control panel will be shown to move the picture after zoom-in is performed.
Take snapshots		Click to take a snapshot of the current view on a new window. Right click on the picture and re-save it to the location you want.
Zoom in / out	 / 	Click  once to enlarge the picture by 1X, and click  once to restore the zoom ratio by 1X.
Max. zoom in / out	 / 	Click  once to enlarge the picture to the max zoom ratio by 16X, and click  once to restore the picture ratio to 1X.
Normal Size		The current live view size is the same as the selected resolution. <i>This icon appears only when the selected resolution is 1280 x 720 or above.</i>
Scale		Click and hold the movable square on the left bottom corner of the live view to move <i>This icon appears only when the selected resolution is larger than the current live view size.</i>

2.4 Event Record Search & Playback

Note: To save more recorded data, it's recommended to use this camera with a compatible NVR.



	Previous / Next Hour	Click to jump to the next / previous time interval in an hour, for example, 11:00 ~ 12:00 or 14:00 ~ 15:00, and start playing the earliest event video clip recorded during this whole hour.
	Fast Forward	Increase the speed for fast forward. Click to get 2X, 4X, 8X & 16X speed forward eventually.
	Fast Rewind	Increase the speed for fast rewind. Click to get 2X, 4X, 8X & 16X speed rewind eventually.
	Play	Click to play the current video clip.
	Pause	Click to pause the video playback.
	Stop	Click to stop the video playback.
	Step	In the pause mode, click to get one frame forward.
	Audio	Click to mute the playback if necessary, and click again to restore.
	Download	Click to download the current video clip to the specified path in your PC. <i>The downloaded video can only be opened by our own video player. Please go to "General" → "Maintenance" to download the video player, or get the player from the CD supplied with the sales package.</i>

3. CAMERA CONFIGURATIONS

Users can further configure this network camera by accessing via Internet Explorer.

3.1 System configuration menu

Click “Config.” to enter the configuration page.

The functions are categorized into seven menus: Network, Camera, VA, Record, Storage, Trigger and General.

- For details about “Network”, please refer to “3.2 Network” at page 10.
- For details about “Camera”, please refer to “3.3 Camera” at page 16
- For details about “VA”, please refer to “3.4 VA (For selected models only)” at page 21
- For details about “Record”, please refer to “3.5 Record” at page 21.
- For details about “Storage”, please refer to “3.6 Storage” at page 22.
- For details about “Trigger”, please refer to “3.7 Trigger” at page 22.
- For details about “General”, please refer to “3.8 General” at page 24.

Main Menu	Sub-Menu	Reference
Network	Network	Configure network settings.
	QoS	Limit the data flow for live streaming.
	DDNS	Enter DDNS information when the network type is PPPOE or DHCP.
	SNTP	Synchronize your camera time with the networked computer systems.
	FTP	Enter the FTP information for event notifications when “FTP” is chosen in “Trigger” → “Trigger”.
	Mail	Enter Email information for event notifications when “Email” is chosen in “Trigger” → “Trigger”.
	SMS	Enter text messaging information for SMS notifications when “SMS” is chosen in “Trigger” → “Trigger”.
	Filter	Choose to permit or block the IP address(es) which can access this camera.
	UPnP	<i>*Suitable for Windows-based operating system.</i> Allow this camera to be detected among devices within the same network area for easy and quick usage.
	Bonjour	<i>*Suitable for Apple Mac-based operating system.</i> Allow this camera to be detected among devices within the same network area for easy and quick usage.
	RTP	Set the parameters for video data transmission when you’re using multimedia other than web browsers and Video Viewer for remote access.
	SNMP	Configure SNMP to remotely manage network devices.
	IEEE 802.1X*	The settings here enable the camera to access a network protected by 802.1X/EAPOL (Extensible Authentication Protocol Over LAN).
	Network Share	Assign a location in the LAN environment to save the snapshot of events when “Network Share” is chosen in “Trigger” → “Snapshot”.
	Network Failure Detection	Configure this camera to check the network connection of other device periodically, and send notifications via Email or FTP for disconnection events.
Camera	Camera	1. Rename the camera. 2. Change the place where the camera name is shown on the screen.
	Video	Adjust video-related settings in different video format.
	ROI*	Select a specific area to reinforce the image quality of that area.
	Color	Adjust the color performance.
	Audio	Adjust the audio volume of the microphone and speaker.
	Advanced	Adjust the camera parameters if necessary.
	Privacy Mask*	Cover certain areas on the camera image.
VA*	TA*	This function should be used with the mini-guard control switch for alarm system integration. For details, please check with your distributor or installer.
Record	Record	Configure the record function.
	Record Timer	Schedule external alarm recording.
Storage	Memory	Check the current storage capacity and clear all recorded data when needed.

**Selected models only*

Main Menu	Sub-Menu	Reference
Trigger	Trigger	<ol style="list-style-type: none"> 1. Enable / disable the motion detection. 2. Set the motion detection area. 3. Configure how the camera reacts for any event.
	Snapshot	Schedule the camera to take snapshots periodically or at a specific time, and send to E-Mail, FTP and / or Network Share for backup. Time-lapse recording could also be configured here.
General	General	<ol style="list-style-type: none"> 1. Select the language of the web browser. 2. Check the MAC address of the camera. 3. Lock camera access after the specified time.
	Time	Set daylight saving time and the current time.
	Server Log	Check the system event logs.
	Online	Check the current online user(s).
	Account	<ol style="list-style-type: none"> 1. Create a new user account with different access privilege. 2. Modify or delete an existing user account.
	Google Maps	Allow you to know where the network camera is.
	Maintenance	<ol style="list-style-type: none"> 1. Check the current firmware version and upgrade your camera. 2. Copy system configurations. 3. Reboot the camera. 4. Download the video player to play the recorded data.

**Selected models only*

3.2 Network

3.2.1 Network

You can set the network configuration of the network camera depending on your network type.

For details, please refer to “Advanced Network Setup” from www.surveillance-download.com/user/m650.swf.

3.2.2 QoS

QoS, Quality of Service, is the ability to control the data flow for real-time streaming. This function is important if your network bandwidth is insufficient and you have other devices to share the network bandwidth.

Check “QoS Enable”, and set the max. upload rate from 256 to 10240 kbps.

3.2.3 DDNS

Select “On” when the selected network type in “Network” is “PPPOE” or “DHCP”.

For details, please refer to “Advanced Network Setup” from www.surveillance-download.com/user/m650.swf.

3.2.4 SNTP

SNTP (Simple Network Time Protocol) is used to synchronize your camera time with the networked computer..

Function	Description
GMT	Once users choose the time zone, the network camera will adjust the local area time of the system automatically.
NTP Server	Simply use the default SNTP server (For example, tock.stdtime.gov.tw) or change to another server with which users are familiar.
Sync. Period	Select “Daily” to synchronize the camera time with the network time every day or “None” to turn off this function.
Sync	Click and the network camera will synchronize the time with the network time.

3.2.5 FTP

Enter the detailed FTP information and click “Save” to confirm. The information you set here will be applied when “FTP” is selected in “Trigger” → “Trigger”.

FTP Configuration

Username:

Password:

Server:

Port:

Directory:

Mode:

3.2.6 MAIL

Enter the detailed e-mail information and click “Save” to confirm. The information you set here will be applied when “Email” is selected in “Trigger” → “Trigger”.

SMTP Configuration

SMTP Server:

Port:

Mail From:

Use SSL Encryption: Yes No

Verify Password: Yes No

Username:

Password:

Subject:

E-Mail Address List

E-Mail Address:

Receiver Name	E-Mail Address
boss	boss@tech.com

Function	Description
SMTP Server	Enter the SMTP server address provided from your e-mail system supplier.
Port	Enter the port number provided from your e-mail system supplier. If this column is left blank, the e-mail server will use port 25 to send e-mails.
Mail From	Enter the name of the sender.
SSL Encryption	Select “Yes” if your e-mail server is using SSL encryption to protect your e-mail content from unauthorized access.
Verify Password	Some mail servers are required to verify the password. Please enter the “user name” and “password”.
Subject	Enter the subject for the E-Mail.
E-Mail Address List	Add the e-mail address(s) of the assigned recipient(s).
Test	When all information is entered, click “Test Mail” to try if the receipt.

3.2.7 SMS

Note: Before using this function, you need to apply an account and get an API ID from the mobile messaging company, such as Clickatell and EVERY8D. For details, please refer to "APPENDIX 4 API ID APPLICATION FOR SMS MESSAGING" at page 33.

Enter the detailed information needed for text messaging, and click "Save" to confirm. The information you set here will be applied when "SMS" is selected in "General" → "Trigger".

The screenshot shows the 'SMS Configuration' window. It contains the following fields and controls:

- System:** A dropdown menu with 'clickatell' selected.
- Username:** A text input field containing 'tech'.
- Password:** A text input field with masked characters '*****'.
- API ID:** A text input field containing '3281378'.
- Recipient:** A text input field containing '+886912665475' with a small flag icon to the left.
- Transfer Interval:** A dropdown menu with '15' selected, followed by the text 'Minute(s)' and a 'Reset Counter' button.
- Message:** A text area containing '[192.168.1.10] unauthorized access!' and a checked checkbox labeled 'Include Hostname or IP'.
- Buttons:** 'Save', 'Test', and 'Reload' buttons are located at the bottom of the form.

Function	Description
System	The text messaging service provider is Clickatell.
User name / Password	Enter the account user name and password you created in Clickatell.
API ID	Enter the API ID you applied from Clickatell.
Recipient	Click "Add" to enter the phone number, including the country code, to receive the text message. Five sets of phone numbers are allowed.
Transfer Interval	Set the interval time in minutes between two-message sending. The options are 0, 15, 30 & 60.
Reset Counter	Click to restart the text messaging, and the SMS will be sent after the specified time interval since you click this button.
Message	Enter the text content (up to 70 characters) you want to send with the text message.
Test	To know whether your SMS setting is correct, click this button to immediately send a SMS to your phone. Note: This testing is not free and you will be charged for SMS sending base on your local rate.

3.2.8 Filter

Choose to permit or block the IP address(es) which can access this camera, and click “Save” to confirm.

Function	Description
Filter Configuration	
Error Count	Set the maximum count for login failure. When the maximum count is reached, the IP address trying to access the network camera will be locked.
Error Lock Time	Set the lock time in minutes when the maximum count of error login for an IP address is reached.
Echo Request	Select “Non-Block” to allow other users to use the ping command to detect the IP address of your network camera, or “Block” to deny the ping command request.
IP/MAC Filter Configuration	
IP/MAC Filter	Choose to enable or disable the filter function.
IP/MAC Filter Policy	If “Enable” is selected, choose whether you want to permit (Allow) or block (Deny) the IP address list below.
IP/MAC Filter Rules	
Rule	<ul style="list-style-type: none"> To add an item to the IP address list, key in the IP address in “Rule”, and click “Add”. To remove an existing item in the IP address list, click the item you want to remove, and click “Delete”.

3.2.9 UPnP / Bonjour

“UPnP” stands for “Universal Plug and Play”, which allows devices to connect seamlessly in the home and corporate environments and simplify installation of computer components, and is only suitable for Microsoft Windows-based operating system.

“Bonjour” functions the same as “UPnP”, but it’s only suitable for Apple Mac-based operating system.

➤ UPnP

➤ Bonjour

Check “Enable” to allow the network camera to be detected among devices within the same network area, and set the identification name of the camera in “Friendly name”.

When this function is activated, the other PC within the same domain as this camera will be able to search this camera in:

- “Network Neighbor” with the identification name set in “Friendly name” for Windows-based PC, or
- “” (finder) or “Bookmark” with the identification name set in “Device Name” for Mac-based PC.

Double-click it to quickly open the web browser for camera access.

Port Mapping (Available only in UPnP)

This function can eliminate the need to additionally access the router for port forwarding.

For details, please refer to “Advanced Network Setup” from www.surveillance-download.com/user/m650.swf.

Note: Before using this function, make sure your router supports UPnP, and this function is enabled. If not, please access your router additionally for port forwarding.

When “Port Mapping” is set to “Enable”, the system will automatically assign an IP address or port number for you if no IP address or port number is entered.

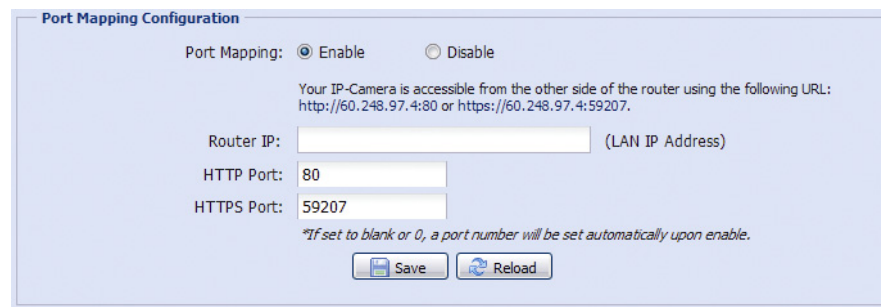

The screenshot shows the 'Port Mapping Configuration' window. It has a title bar 'Port Mapping Configuration'. Below the title bar, there are two radio buttons: 'Enable' (selected) and 'Disable'. Below that, a text box says 'Your IP-Camera is accessible from the other side of the router using the following URL: http://60.248.97.4:80 or https://60.248.97.4:59207.' Below this, there are three input fields: 'Router IP:' (empty), 'HTTP Port:' (80), and 'HTTPS Port:' (59207). Below the input fields, there is a note: '*If set to blank or 0, a port number will be set automatically upon enable.' At the bottom, there are two buttons: 'Save' and 'Reload'.

Note: When the configurations are saved successfully, you’ll see a message indicating the IP address and port number assigned to this network camera.

3.2.10 RTP

The Real-time Transport Protocol (RTP) is an Internet protocol standard to manage the real-time transmission of multimedia, such as VLC player.

The media player you want to use for remote access must support RTP transmission for this function to work normally.

Note: When you’re about to end the remote access, please press the stop button on your media player first, and then close the program. This is to ensure the server receives the stop command, and also help to protect the server from redundant data transmission.

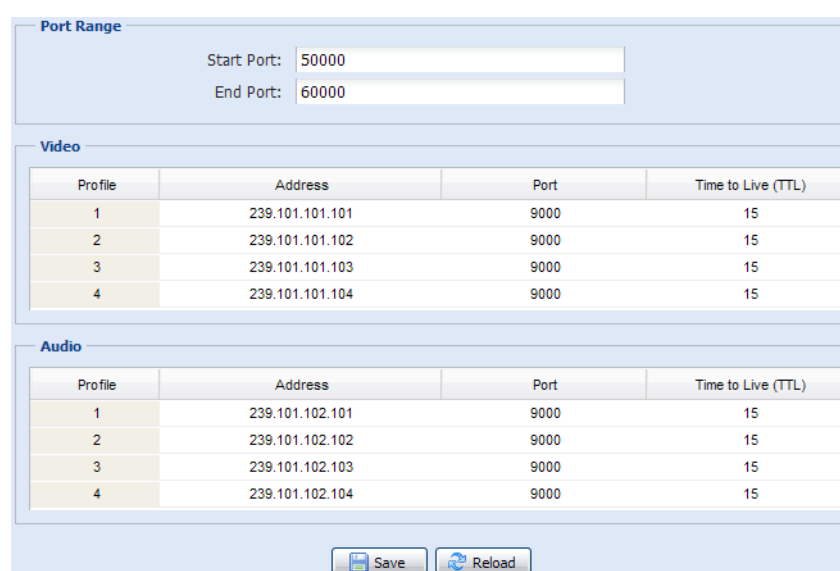

The screenshot shows the 'Port Range', 'Video', and 'Audio' configuration sections. The 'Port Range' section has two input fields: 'Start Port:' (50000) and 'End Port:' (60000). The 'Video' section has a table with 4 columns: Profile, Address, Port, and Time to Live (TTL). The 'Audio' section has a table with 4 columns: Profile, Address, Port, and Time to Live (TTL). At the bottom, there are two buttons: 'Save' and 'Reload'.

Profile	Address	Port	Time to Live (TTL)
1	239.101.101.101	9000	15
2	239.101.101.102	9000	15
3	239.101.101.103	9000	15
4	239.101.101.104	9000	15

Profile	Address	Port	Time to Live (TTL)
1	239.101.102.101	9000	15
2	239.101.102.102	9000	15
3	239.101.102.103	9000	15
4	239.101.102.104	9000	15

Function	Description
<ul style="list-style-type: none"> Port Range The port range used by RTP is limited, and preserving 100 ports between the start port and end port is necessary. 	
Start Port	The range of the start port is 1024 ~ 65434.
End Port	The range of the end port is 1124 ~ 65534.
<ul style="list-style-type: none"> Video 	
Address and port for video transmission	Set a specific address and port for multicast of profile 1 ~ 4. The range of the address is limited between 224.0.0.1 ~ 239.255.255.255. The port for multicast must be an even number.
<ul style="list-style-type: none"> Audio 	
Address and port for audio transmission	Set a specific address and port for multicast of audio. The range of the address is limited between 224.0.0.1 ~ 239.255.255.255. The port for multicast must be an even number.

3.2.11 SNMP

SNMP, Simple Network Management Protocol, is used to facilitate the exchange of management information between network-attached devices, and network administrators could use it to monitor those devices.

The SNMP consists of three basic components:

- Network-management systems (NMSs)** to monitor and control the managed devices.
- Managed devices** as network nodes to save all network and management information, such as routers, access servers, switches, bridges, hubs, etc.
- Agents** as network management software modules on managed devices to provide the status of managed devices to NMSs.

Note: Before configuring SNMP settings, make sure your NMS is enabled first.

Enable SNMP V1 / V2C

Select “Yes” to enable this function, and enter the names of “Read community” and “Write community” based on your NMS configurations.

To enable “Traps” to notify the management station of important events, choose “V1” or “V2C” in “Enable”, enter the address and community name, and select the event type(s) needed.

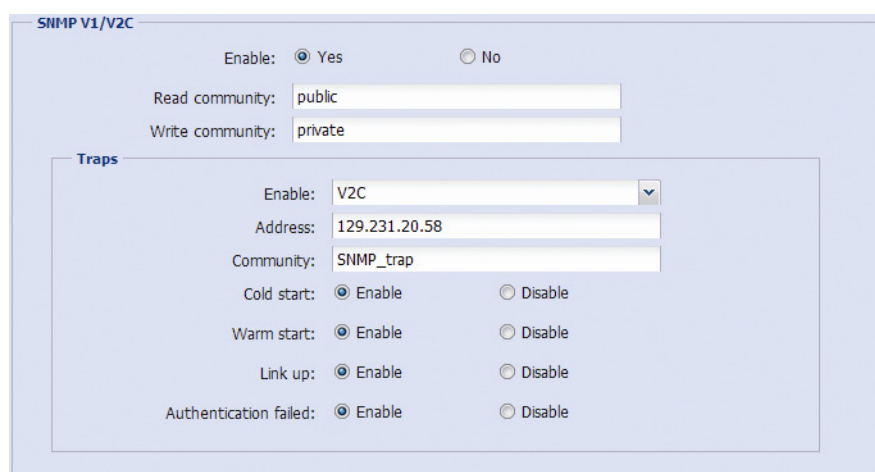

SNMP V1/V2C

Enable: Yes No

Read community:

Write community:

Traps

Enable:

Address:

Community:

Cold start: Enable Disable

Warm start: Enable Disable

Link up: Enable Disable

Authentication failed: Enable Disable

Enable SNMP V3

SNMP V3 has a higher security level than SNMP V1 / V2C to allow configuring the authentication password and encryption password.

Choose “Read/Write Security name” or “Read only Security name” based on your NMS settings, and enter the community name. Then, select the authentication type from “MD5” or “SHA”, and enter the password for authentication and encryption. The password length is from 8 to 31 characters.



The image shows a web-based configuration interface for SNMP V3. It features two sections for configuration. The first section is for 'Read/Write Security name' with a text input field containing 'Private', a dropdown menu for 'Authentication Type' set to 'MD5', and two empty text input fields for 'Authentication Password' and 'Encryption Password'. The second section is for 'Read only Security name' with a text input field containing 'Public', a dropdown menu for 'Authentication Type' set to 'MD5', and two empty text input fields for 'Authentication Password' and 'Encryption Password'. At the top, there is an 'Enable' section with radio buttons for 'Yes' (selected) and 'No'.

3.2.12 IEEE 802.1X (For selected models only)

The settings here enable the camera to access a network protected by 802.1X/EAPOL (Extensible Authentication Protocol Over LAN).

Note: For authentication to work properly, it's important to synchronize the time in the camera with an NTP server.

Before using this function, make sure:

- The switch and RADIUS server you have in the LAN environment supports IEEE 802.1X, and IEEE 802.1X settings are enabled.
- You've applied a digital certificate from a Certificate Authority which can be validated by a RADIUS server, and the identity and password used.

Then, follow the steps below:

Step1: Connect this camera to a PC or laptop directly, and go to its login page to log in.

Note: To know how to connect the camera to a PC or laptop directly, please check “4 Modem / Hub + Modem” in “[ADVANCED NETWORK SETUP](#)”.

Step2: Log into the camera, and go to “Config” → “Network” → “IEEE 802.1X”. Enable this function, and select the EAP method you want to use.

Note: This camera supports “EAP-PEAP”, “EAP-TLS” and “EAP-TTLS”.

Step3: Enter the identity and password you get from the Certificate Authority, and select the EAPOL version used in your switch.

Step4: Upload the certificate(s) issued by the Certificate Authority, and save.

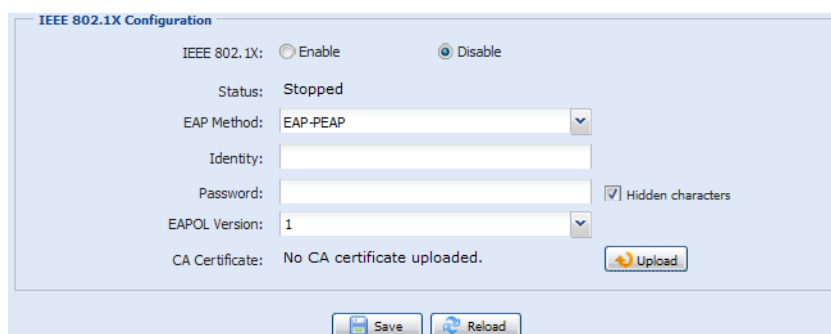

The image shows a web-based configuration interface for IEEE 802.1X. It features a title 'IEEE 802.1X Configuration'. At the top, there are radio buttons for 'Enable' and 'Disable', with 'Disable' selected. Below this, the 'Status' is shown as 'Stopped'. There is a dropdown menu for 'EAP Method' set to 'EAP-PEAP', followed by text input fields for 'Identity' and 'Password'. A checkbox for 'Hidden characters' is checked. Below these is a dropdown menu for 'EAPOL Version' set to '1'. At the bottom, there is a text field for 'CA Certificate' with the value 'No CA certificate uploaded.' and an 'Upload' button. At the very bottom, there are 'Save' and 'Reload' buttons.

Step5: Disconnect the camera from your PC or laptop, and connect it to the switch in the LAN environment you want to use IEEE 802.1x, and the camera will start the authentication later.

3.2.13 Network Share

This function is used to assign a location in the LAN environment to save the snapshot of events.

Note: This function is available only for Windows operating systems.

The information you set here will be applied when “Network Share” is selected in “Trigger” → “Snapshot” → “Storage Mode”.

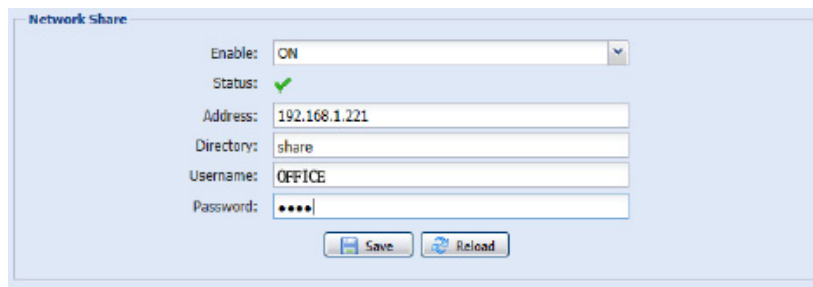

To use this function, make sure:

- A PC is installed in the same LAN environment as this camera, and you know the IP address of the PC.
- A PC account is created as “Administrator” with a user name and password.
- A folder in the PC is opened as shared to the user account you assigned.

Note: Please check “APPENDIX 7 PREREQUISITES FOR NETWORK SHARE” at page 37 for more details.

Enable this function, and enter the address of the PC, the folder being shared, and the user name and password to access the PC. If the information is all correct, you'll see a check in the “Status” column, and you're ready to go to “Trigger” → “Snapshot” for further configurations.

3.2.14 Network Failure Detection

Configure this camera to check the network connection of other device periodically, and send notifications via Email or FTP for disconnection events.

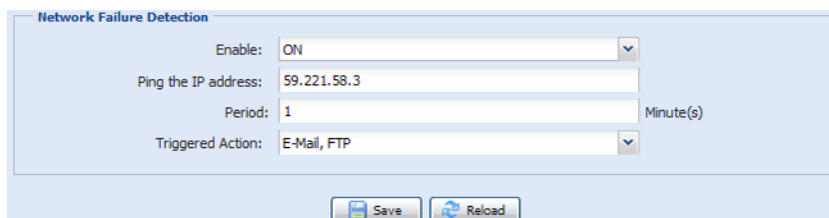

3.3 Camera

3.3.1 Camera

In this menu, you can set the camera title, OSD display, and location to save snapshots.

Note: The actual functions shown depend on the model you have.

■ Type1



■ Type2

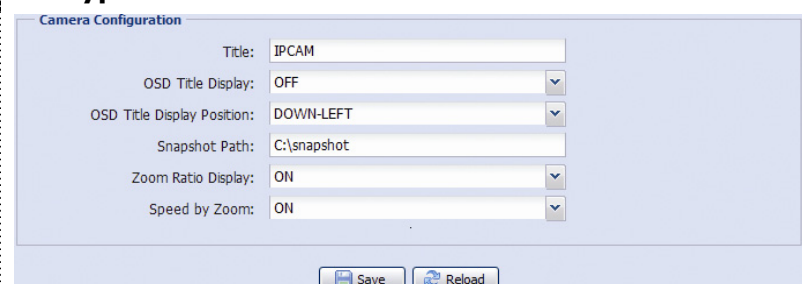

3.3.2 Video

Adjust video-related settings in different video format.

- “Quality” is related to image clearness.
- “FPS” is related to the fluency of the video. The more the FPS, the more fluent the video.
- “Max Bit Rate” is the maximum limitation of data transmission in the selected image format and resolution.

Note: QQVGA is for mobile surveillance only.

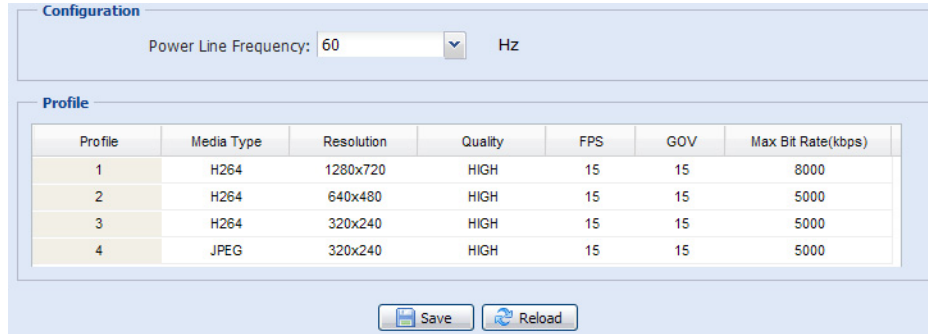

3.3.3 ROI (For selected models only)

ROI, Region of Interest, is used to reinforce the image quality of the selected area(s). Users could specify two areas in the camera view.

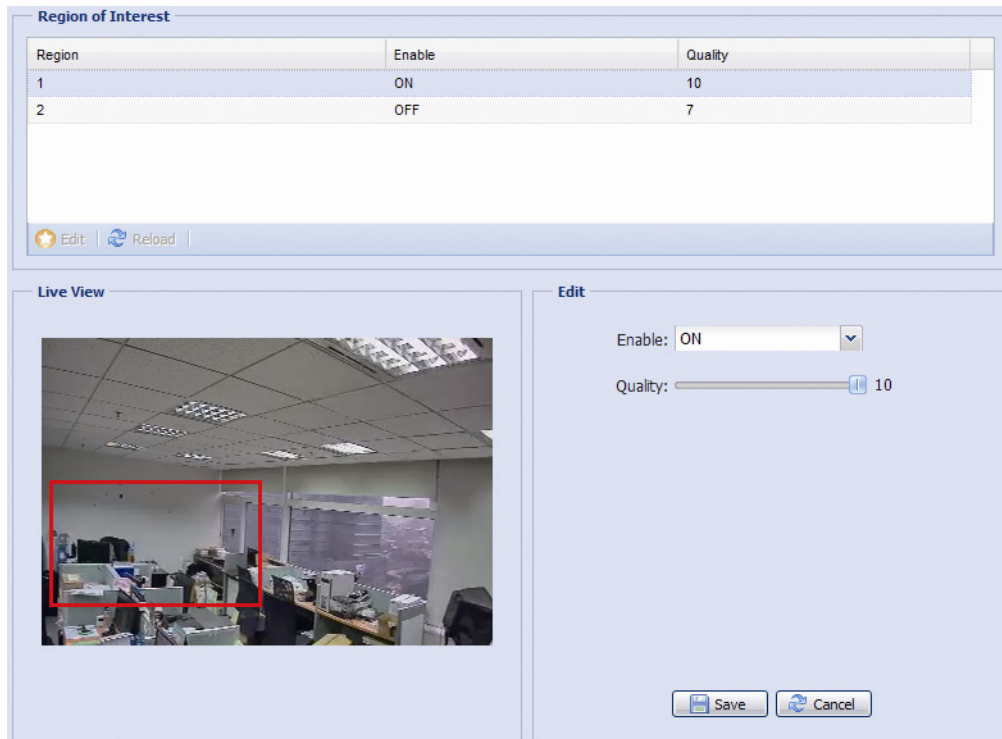

3.3.4 Color

Adjust the color performance from Brightness, Contract, Saturation, and Hue. Click and drag the slider to preview the color change on the right side of this page and adjust the image color.

To restore the default values, click “Back to Default”.

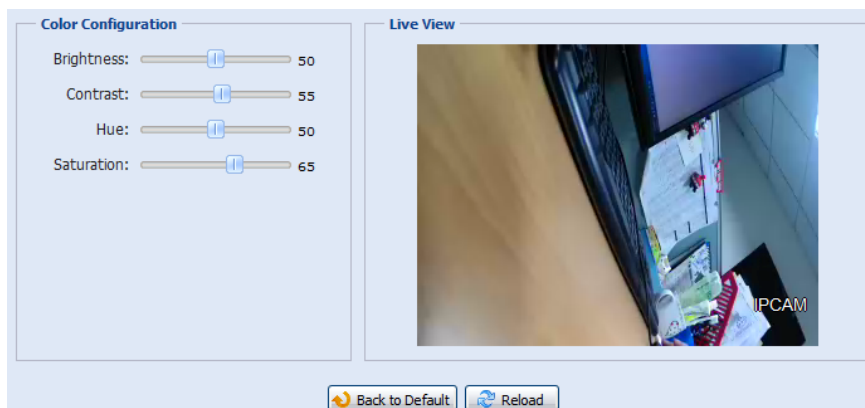

3.3.5 Audio

Drag the slider to adjust the volume of the microphone and speaker.

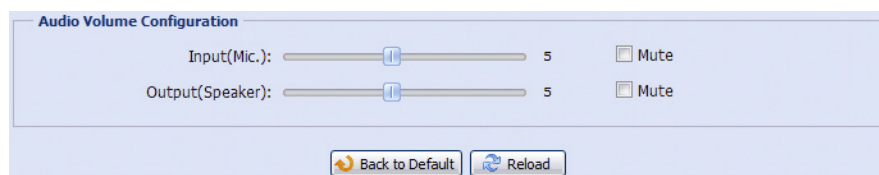

3.3.6 Advanced

Adjust the camera parameters if necessary.

Note: The functions available depend on the model number used.

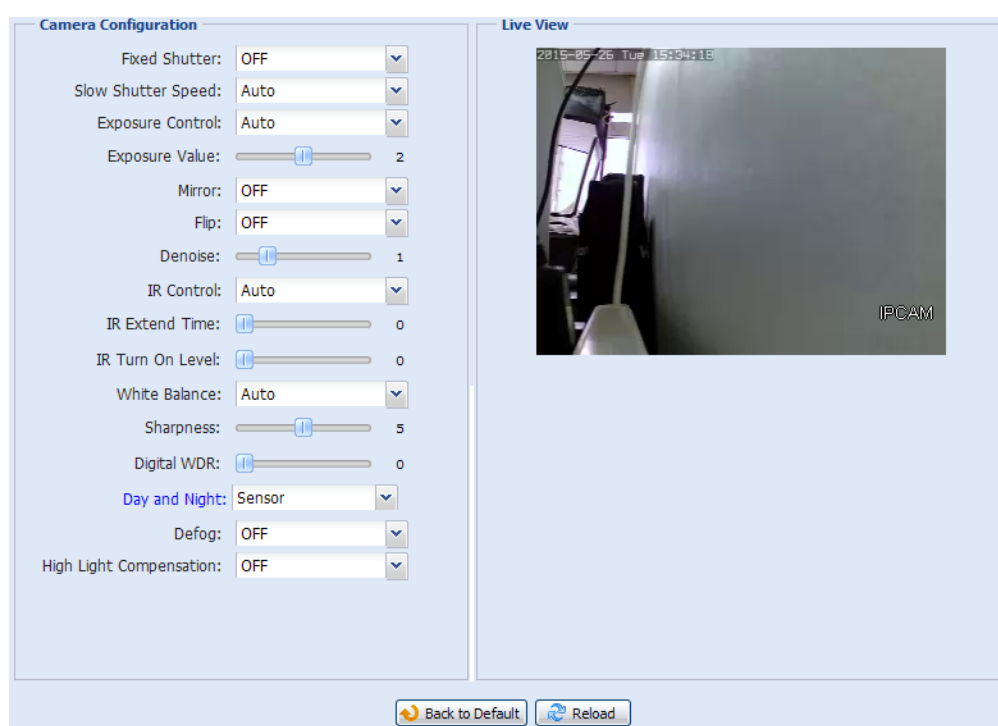

Item	Description
Fixed Shutter*	Shutter Speed is a function that can adjust the duration of the electronic shutter to produce optimum image quality. Select the shutter speed suitable for your environment.
Slow Shutter Speed	Select the slow shutter speed suitable for your environment: Up to 1/30 sec., Up to 1/15 sec., Up to 1/10 sec., or Up to 1/6 sec. A slower shutter speed in dark conditions will help to produce a brighter image, but will produce fewer frames per second, which may cause images to get blurry during motion.
Exposure Control	This function is used to synchronize the shutter time to the fluorescent light to suppress image flickering.
Exposure Value*	Drag the slider to adjust the exposure level from 0 ~ 4.
Mirror	Select "ON" to rotate the images horizontally based on your installation situation when necessary.
Flip	Select "ON" to rotate the image 180° when necessary.
Denoise	Click and drag the slider to adjust the level from 0 ~ 10 to decrease the noise shown in the dark environment.
IR Control	Select "Auto" to automatically enable IR LEDs at night or in the dark environment, "On" to always enable IR LEDs, or "OFF" to disable this function.
IR Extend Time*	Set the delay time from 1 ~ 60 in second after which the day and night switch is made, or select 0 to disable this function. This is used for the environment where the light condition may change suddenly and usually last for a short time, for example, the entrance of a parking lot. It may cause the day & night mode switching constantly and damage the camera. With this function, the camera will delay the mode switch at night since the light change is temporary and unnecessary to pay attention.
IR Turn On Level*	Select the level for IR light to activate.
White Balance	Process the current image to retain color balance over a color temperature range. The options are: Auto, 2500K, 3200K, 4200K, 5800K & 9500K.
Sharpness	Sharpness enhances the clarity of image detail by adjusting the aperture and sharpening the edges in the pictures. Hold and drag the slider to adjust the level of sharpness. The higher the value, the sharper the image.
Digital WDR	Digital WDR is used to simulate the effect of WDR when users need to increase image recognizability in overexposure and dark areas.

Item	Description
Day and Night*	<p>This function is used to configure the day and night mode:</p> <ul style="list-style-type: none"> Day - Always stay in the day mode (color). Night - Always stay in the night mode (B/W). Image - Automatically switch based on the light condition of the image captured Time – Select this option, and click “Day and Night” in blue to enable and set a schedule to enable day and night mode. The selected time (yellow) will be in the day mode, and the unselected time will be in the night mode. Sensor – Use the built-in light sensor for day and night detection. Digital Input N.O. – (Used with Alarm In) Normally stay in the day mode, and switch to the night mode when the alarm is triggered. Digital Input N.C. – (Used with Alarm In) Normally stay in the night mode, and switch to the day mode the when alarm in triggered.
Defog*	Select ON to enable the defog function in poor weather conditions such as fog, smog or smoke. The captured image can be improved.
High Light Compensation*	It's used to suppress strong backlight for clearer images. Select “ON”, and a gray mask will be covered on the source of the strong light.

*Selected models only

3.3.7 Privacy Mask (For selected models only)

You can cover certain areas on the camera image with privacy masks.

Item	Description
Mosaic Size	Choose the mosaic size of the privacy mask when “Mosaic” is set to “ON”. The options are: 8x8, 32x32, and 64x64.
Privacy Mask Name	Name your privacy mask.
Function	Select “On” to enable the privacy mask function.
Mosaic	Select “ON” to have the mosaic effect.
Color	Select “ON” to color the privacy mask.
Mask Color	Select the color for the privacy mask.
Transparency	Select the transparency for your privacy mask. The options are: 0%, 25%, 50%, and 100%.
Line Width	Choose the line width from 0, 2, 4 and 6 when the transparency is not set to 0%.

3.4 VA (For selected models only)

3.4.1 TA

TA, tampering alarm, should be used with the mini-guard control switch for alarm system integration. For more details, please check with your distributor or installer.

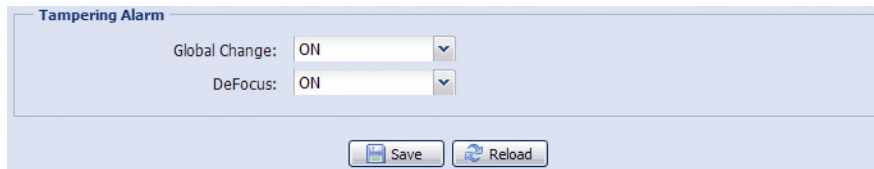

Tampering Alarm

Global Change: ON

DeFocus: ON

Save Reload

3.5 Record

3.5.1 Record

- Enable or disable the alarm record function. When “Enable” is set to “No”, the alarm record function is disabled even if you enable it in other configuration pages.
- Select if the data should be overwritten when the memory storage is full.
- Enable or disable the audio record function.
- Select the video resolution for event recording.

Note: The higher resolution you choose, the more accuracy and higher image quality the recording will be, but the faster the memory storage is consumed and become full

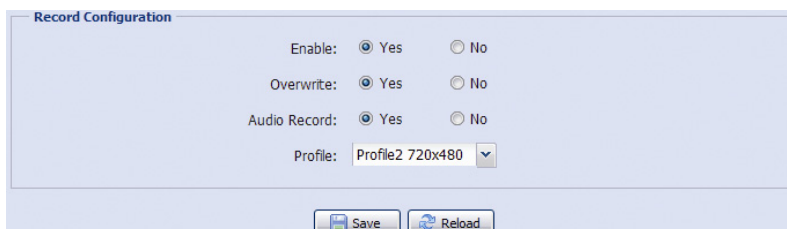

Record Configuration

Enable: Yes No

Overwrite: Yes No

Audio Record: Yes No

Profile: Profile2 720x480

Save Reload

3.5.2 Record Timer

To schedule alarm and motion recording, enable it, and select the day and time for recording.

Note: The timer must be enabled for the record function to work properly.

Note: The selected time will be yellow-colored.

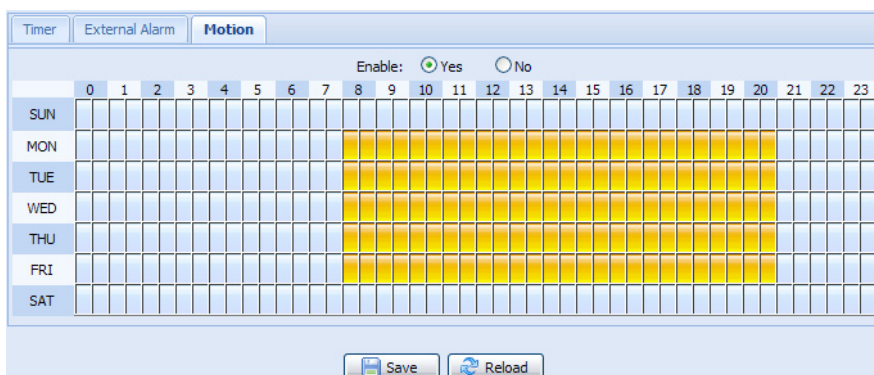

Timer External Alarm Motion

Enable: Yes No

	0	1	2	3	4	5	6	7	8	9	10	11	12	13	14	15	16	17	18	19	20	21	22	23
SUN																								
MON																								
TUE																								
WED																								
THU																								
FRI																								
SAT																								

Save Reload

3.6 Storage

3.6.1 Memory

In “Memory”, you can check the remaining capacity for recording, or clear all recorded data saved if needed.

Note: The recorded data will be removed also when you reset or reboot this camera.

Note: To save more recorded data, it’s recommended to use this camera with the compatible NVR.

Note: To know the total recording time per recording resolution, please refer to “APPENDIX 6 RECORDING TIME TABLE” at page 36.

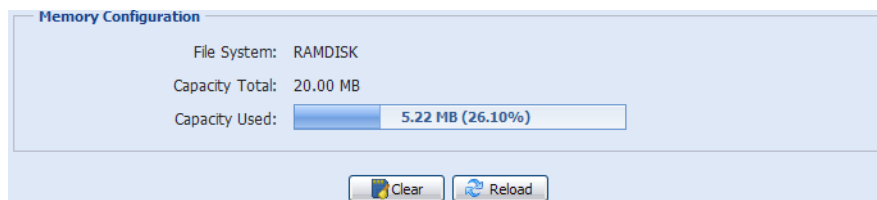

3.7 Trigger

3.7.1 Trigger

You can configure how this camera reacts when there’s an alarm or motion event.

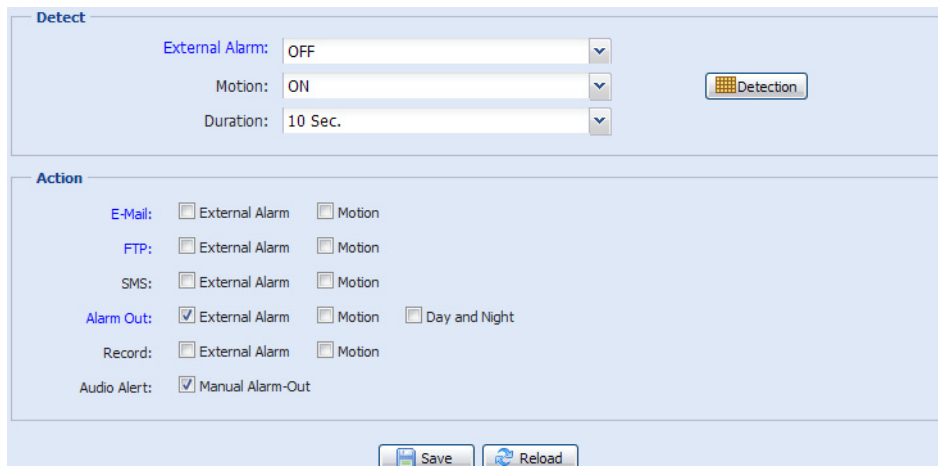

◆ Detect

Item	Description
External Alarm	Enable or disable detection from external alarm-in device, and click the title "External Alarm" (in blue) to set "N.O." or "N.C." depending on the configuration of your alarm-in device.
Motion	<p>Enable or disable motion detection.</p> <p><i>Motion detection is not supported when the stream format is Motion JPEG.</i></p> <p>When "Enable" is selected, click "Detection" to enter the motion detection area setting page as follows:</p>  <p>Sensitivity: Set the detection sensitivity from the drop-down list: High, Normal or Low.</p> <p>Area Setting: Set the motion detection area by selecting the area grids with your mouse. Pink grids represent the area that is not being detected while the transparent grids are the area under detection. You can set multiple areas under detection. Click "Clear All" to set the whole area undetected. Click "Select All" to set the whole area under detection.</p>
Duration	Set the duration time for trigger recording (5 / 10 / 20 / 40 seconds).

◆ Action

Here defines how the camera delivers alerts to you for any event.

Item	Description
E-Mail	<p>Select the event type you want to receive E-mail notifications when it occurs.</p> <p>Then, click the title "E-Mail" (in blue) to configure the media type (H264 / JPEG / MPEG4), file format (AVC / AVI), and record time (1 ~ 5 seconds) for the event video clip.</p> <p>The camera will send the captured video clip to the E-mail address(s) you assigned in "Network" → "Mail" once the selected event type occurs.</p>
FTP	<p>Select the event type you want to receive FTP notifications when it occurs.</p> <p>Then, click the title "FTP" (in blue) to configure the media type (H264 / JPEG / MPEG4), file format (AVC / AVI), and record time (1 ~ 5 seconds) for the event video clip.</p> <p>The camera will upload the captured video clip to the FTP site you assigned in "Network" → "FTP" once the selected event type occurs.</p>
SMS	<p>Select the event type you want to receive a text message when it occurs.</p> <p>The camera will send a text message to the mobile phone number you assigned in "Network" → "SMS" once the selected event type occurs.</p>
Alarm Out	<p>Select the event type you want to trigger the alarm-out device to work when it occurs.</p> <p>Then, click the title "Alarm Out" (in blue) to configure the trigger rule (LOW / HIGH).</p> <p><i>*Day and Night is for selected models only.</i></p>
Record	Select the event type you want to enable event recording when it occurs.
Audio Alert	Select the event type you want to enable audio alert when it occurs.

3.7.2 Snapshot

Enable this function to schedule the camera to take snapshots periodically or at a specific time, and send the snapshots to E-Mail, FTP, and / or Network Share for backup.

Note: Before using E-Mail, FTP and Network Share, make sure the related configurations are done in “Network” → “Mail”, “Network” → “FTP”, and “Network” → “Network Share”.

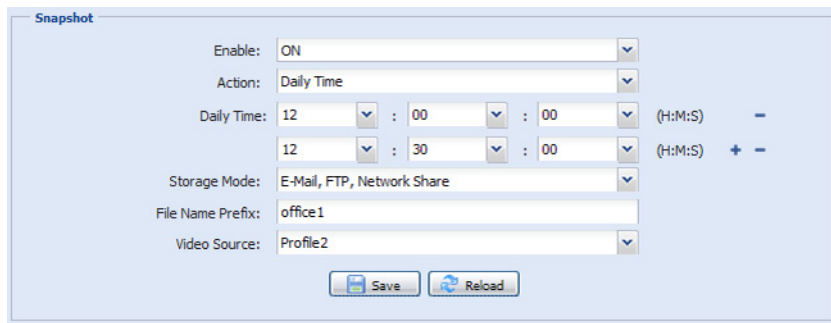

The screenshot shows the 'Snapshot' configuration page. It includes the following fields: 'Enable' set to 'ON', 'Action' set to 'Daily Time', 'Daily Time' set to 12:00:00 (H:M:S), a second 'Daily Time' set to 12:30:00 (H:M:S) with expand/collapse icons, 'Storage Mode' set to 'E-Mail, FTP, Network Share', 'File Name Prefix' set to 'office1', and 'Video Source' set to 'Profile2'. There are 'Save' and 'Reload' buttons at the bottom.

Time-lapse Recording

This function allows users to create time-lapse recording by combining snapshots together.

Note: To use this function, make sure “Network Share” is configured well in “Network” → “Network Share”. For details, please go to “3.2.13 Network Share” at page 17.

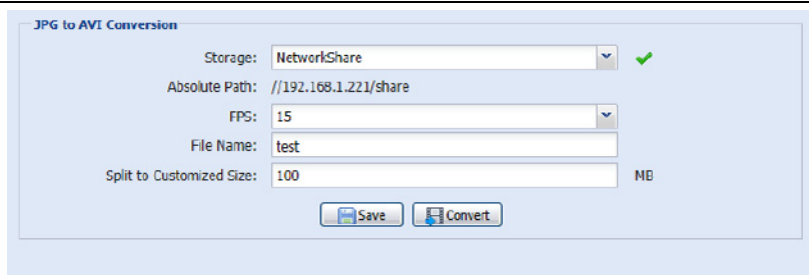

The screenshot shows the 'JPG to AVI Conversion' configuration page. It includes the following fields: 'Storage' set to 'NetworkShare' with a green checkmark, 'Absolute Path' set to '//192.168.1.221/share', 'FPS' set to 15, 'File Name' set to 'test', and 'Split to Customized Size' set to 100 MB. There are 'Save' and 'Convert' buttons at the bottom.

Step1: Configure when to take snapshots in “Snapshot”, and choose “Network Share” as the storage mode.

Step2: In “JPG to AVI Conversion”, choose how many images you want to see per second in “FPS”, name the video file, and specify the file size.

Step3: Click “Convert” to start file conversion, and go to the path specified to store snapshots in “Network Share” to check the video file.

3.8 General

3.8.1 General

To change the language of UI interface, select from the drop-down list in “Language”.

To lock camera access when it’s not used after the specified time, select “5 MIN”, “15 MIN” or “30 MIN” from the drop-down list of “Auto Lock Time”, or select “NEVER” to disable this function.

Note: When the camera access is locked after the specified time, to resume camera access, please enter the password.

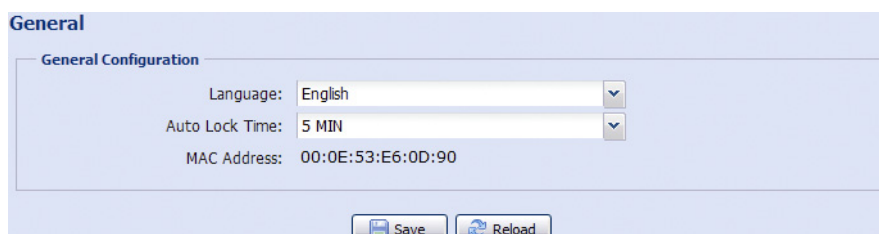

The screenshot shows the 'General Configuration' page. It includes the following fields: 'Language' set to 'English', 'Auto Lock Time' set to '5 MIN', and 'MAC Address' set to '00:0E:53:E6:0D:90'. There are 'Save' and 'Reload' buttons at the bottom.

3.8.2 Time

Set daylight saving time and the current time, and click “Save” to confirm.

Time

Time Configuration

OSD: Enable Disable

Date:

Time: : :

Daylight Saving Time

Daylight Saving Time Configuration

Daylight Saving Time: Enable Disable

Start Time: : (HH:MM)

End Time: : (HH:MM)

Adjust Time: : (HH:MM)

Function	Description
■ Time Configuration	
Date	Set the current date.
Time	Set the current time.
■ Daylight Saving Time Configuration	
Daylight Saving Time	Specify whether to use daylight saving time (Enable / Disable).
	If this function is enabled, set the time period (Start Time / End Time), and adjust the daylight saving time in hours (Adjust Time).

3.8.3 Server Log

To quickly search the system logs you want by event type, click “Prev. Page” or “Next Page” to find the logs you want, or check the event type(s) and click “Reload” to start searching.

To clear all system event logs, click “Clear All”.

Server Log List

No.	Event	Time	Result
1	Remote Login	2011/08/30 20:54:41	admin
2	Remote Login	2011/08/30 20:29:58	admin
3	Remote Login	2011/08/30 18:22:08	admin
4	SNTP Update	2011/08/30 18:20:06	Failed
5	Remote Login	2011/08/30 18:20:03	admin
6	Power On	2011/08/30 18:19:24	ON
7	Power On	2011/08/30 18:18:46	OFF
8	Remote Login	2011/08/30 18:11:21	admin
9	Remote Login	2011/08/30 18:11:18	admin
10	Remote Login	2011/08/30 18:07:10	admin
11	Remote Login	2011/08/30 18:03:19	admin
12	Remote Login	2011/08/30 18:02:15	admin
13	Remote Login	2011/08/30 18:02:07	admin
14	Remote Login	2011/08/30 18:01:51	admin
15	Remote Login	2011/08/30 17:57:01	admin
16	Remote Login	2011/08/30 17:56:55	admin
17	Remote Login	2011/08/30 17:56:53	admin
18	Remote Login	2011/08/30 17:54:44	admin
19	SNTP Update	2011/08/30 17:50:48	Failed
20	Power On	2011/08/30 17:50:07	ON

3.8.4 Online

You can check the current online user(s) with respective online information. To refresh the list, click “Reload”.

- To allow anonymous login, select “Enable” in “Anonymous Viewer Login”.
- To disable image code verification at login, select “No” in “Login with CAPTCHA Image”.

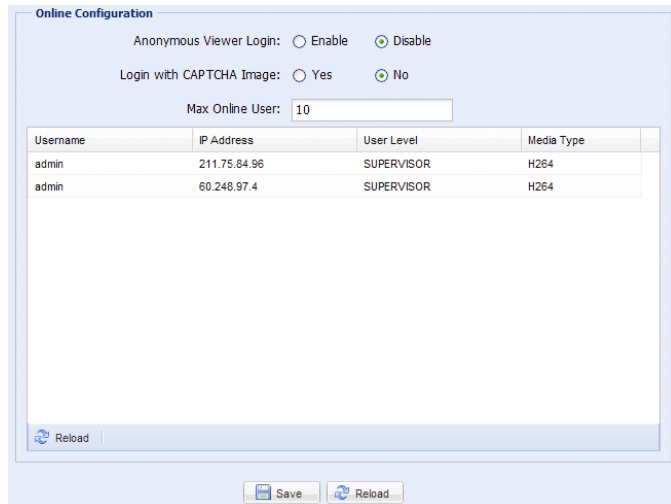

3.8.5 Account

You can create a new account with different user access privilege, or delete or modify an existing account setting.

How to create a new account

Step1: Click “New”, and fill in the following columns.

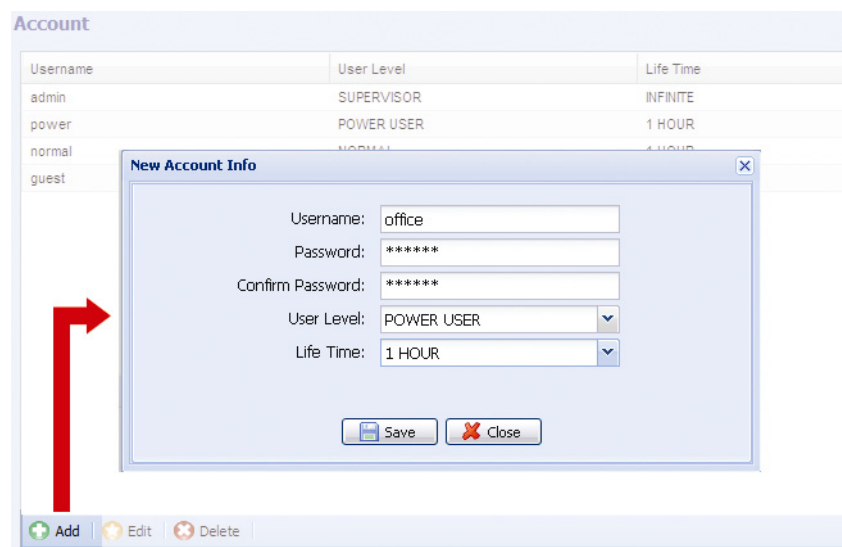

Column	Description
User Name	Set a user name that will be used for camera access. The user name allows up to 16 alphanumeric characters.
Password	Set the password that will be used for remote login. The password allows up to 16 alphanumeric characters.
Confirm Password	Enter the password again to confirm.
User Level	Set the security level of an account to give the permission to control different functions. There are four user levels: SUPERVISOR, POWER USER, NORMAL USER and GUEST.
Life Time	Select how long this account is allowed to stay online (1 MIN / 5 MIN / 10 MIN / 1 HOUR / 1 DAY / INFINITE)

Step2: Then, click “Save” to save your setting and create a new account.

How to modify or delete an existing account

Step1: Select the account you want to modify or delete.

Step2: To modify the account, click “Edit” to change the settings, and click “Save”.

To remove the account, click “Delete”.

Note: It's not allowed to remove an account when there's only one account in the account list.

3.8.6 Google Maps

This function is used to let you know where the network camera is.

The system will prompt you to apply a Google Maps Key if your access is denied. Please follow the instructions below when you're denied:

Step1: Click "Sign up for a Google Maps key" to enter the application page.

Step2: Check the terms and conditions, and enter the IP address of the network camera. Then, click "Generate API Key".

Step3: Copy the generated API key, and click "Update Google Maps Key" on the web browser to paste it.

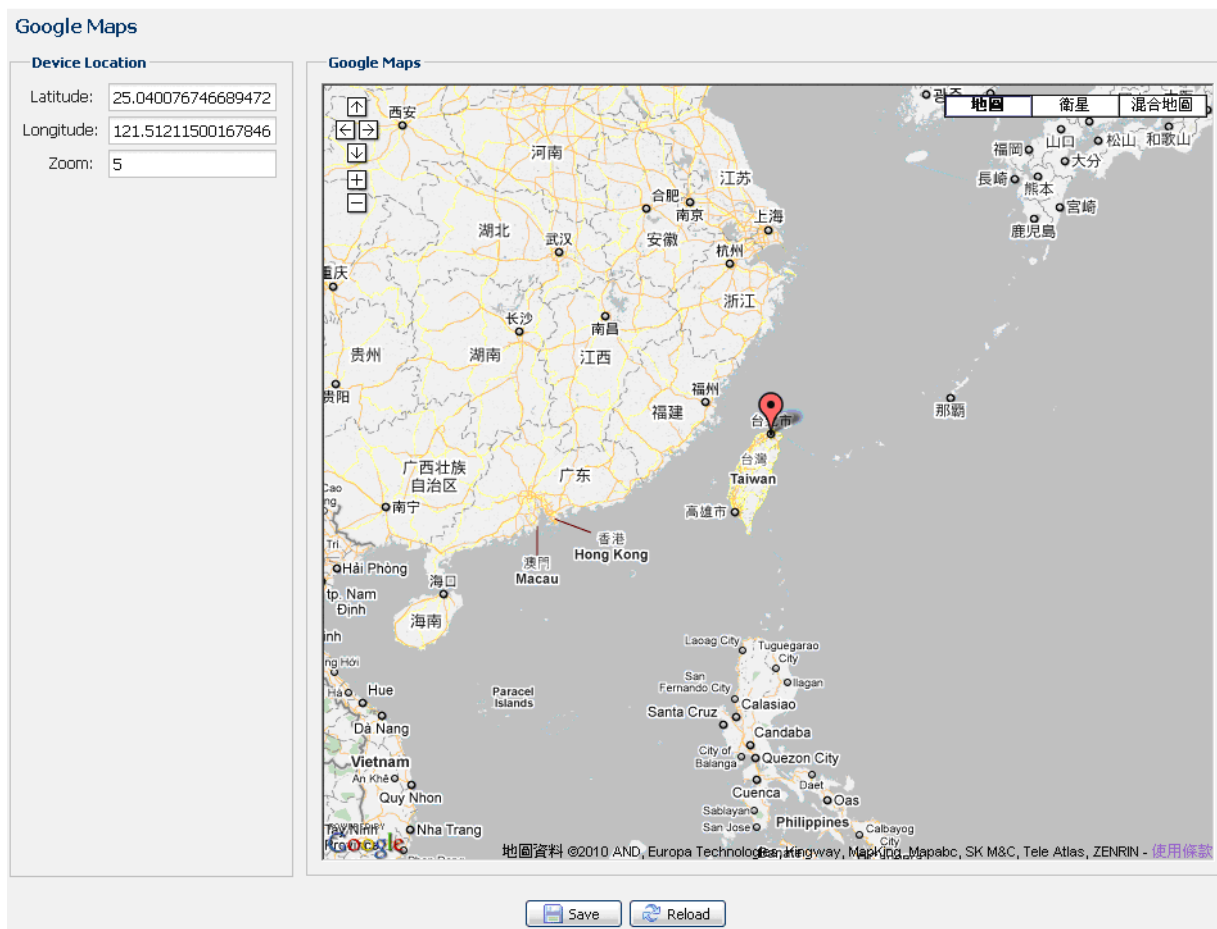

3.8.7 Maintenance

Firmware Upgrade

This function is used when users need to upgrade the camera for function scalability.

Note: Before using this function, make sure you have the correct upgrade files provided by your installer or distributor.

Note: The event videos saved in the camera will be removed after firmware upgrade. Make sure you've copied important events to your PC before firmware upgrade.

Step1: Select "" to browse to where you save the upgrade files, and select them one by one until all files are selected (up to four files).

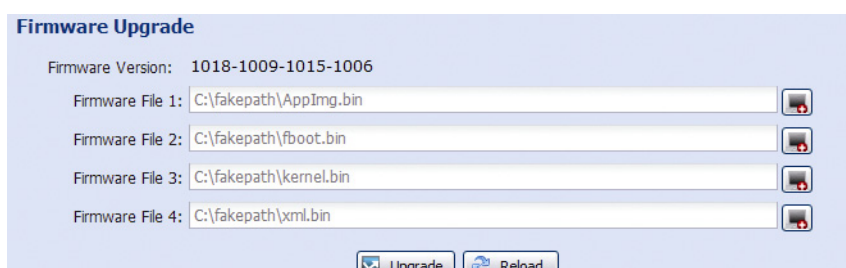

Step2: Select “Upgrade” to start system upgrading.

Note: You’ll be prompted to keep current configurations. It’s recommended to keep them, or all configurations will be restored to default values after upgrade.

Note: It takes a few minutes to finish the upgrade process. Do not disconnect the power during firmware upgrade, or the upgrade may be failed. The camera will reboot after the upgrade.

System Configuration Backup

This function is used to copy your system configuration to a “System.bin” file.

You may import the same system configuration to another camera, or restore your system configuration when the camera is reset to default values.

Select “System.bin” in “Firmware Upgrade”, and select “Upgrade” to import the system configuration.

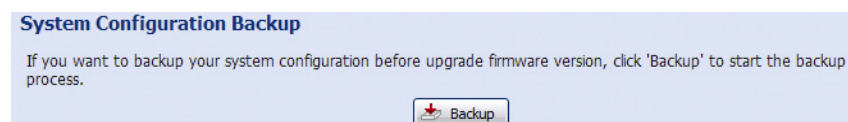

System Reboot

Select “Reboot” to restart your camera if needed.

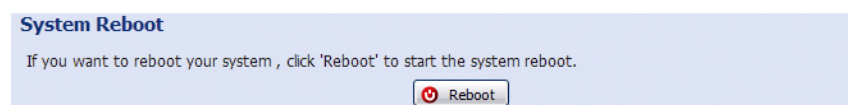

Player Download

To see the event video clips downloaded to your PC, you need to first install our own video player in your PC. Select “Free Download” to download the video player, and double click the file to install it.

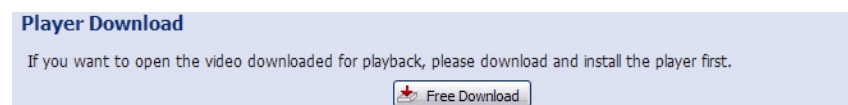

APPENDIX 1 PRODUCT SPECIFICATIONS

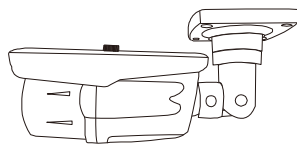

	Model 1	Model 2
■ Network		
LAN Port	YES	
LAN Speed	10/100 Based-T Ethernet	
Supported Protocols	DDNS, PPPoE, DHCP, NTP, SNTP, TCP/IP, ICMP, SMTP, FTP, HTTP, RTP, RTSP, RTCP, IPv4, Bonjour, UPnP, DNS, UDP, IGMP, QoS, SNMP	
ONVIF Compatible	YES (Profile S)	
Security	(1) Multiple user access levels with password (2) IP address filtering (3) Digest authentication	
Remote Access	(1) Internet Explorer on Windows operating system (2) 16CH Video Viewer on Windows & MAC operating system (3) EagleEyes on iOS & Android mobile devices	
■ Video		
Video Compression	H.264 (Main Profile) / MJPEG	
Resolution	2048x1536 / 1920 x 1080 / 1280 x 720 / 720 x 480 / 352 x 240	
Frame Rate	30/25fps	
Multiple Video Streaming	4 (H.264, MJPEG)	
■ General		
Image Sensor	1/3" CMOS image sensor	1/2.8" CMOS image sensor
Min Illumination	0.1 Lux / F1.5; 0 Lux (IR LED ON)	0.1 Lux / F1.4(Wide)~F2.8(Tele), 0 Lux (IR LED ON)
Electronic Shutter	1/10,000 ~ 1/7.5 (Slow shutter)	
S/N Ratio	More than 48dB (AGC off)	
Lens	f3.8mm / F1.5	f2.8 ~ 12mm / F1.4 ~ F2.8
Viewing Angle	67° (Horizontal) / 49° (Vertical) / 87° (Diagonal)	Wide: 94° (Horizontal) / 69° (Vertical) / 120° (Diagonal) Tele: 29° (Horizontal) / 22° (Vertical) / 36° (Diagonal)
IR LED	36 Units	
IR Effective Range	Up to 30 meters	
IR Shift	YES	
Smart Light Control	YES	
White Balance	ATW	
AGC	Auto	
WDR	DWDR	
Privacy Mask	NO	YES
POE (Power-over-Ethernet)	YES (IEEE 802.3af)	
External Alarm I/O	YES (1 input / 1 output)	
Micro SD Card Slot	NO	
IP Rating	IP66	
Operating Temperature	-25°C ~ 50°C	
Operating Humidity	Less than 60% relative humidity	
Power Source (±10%)	12V / 1A	
Current consumption (±10%)	360mA (IR OFF) / 610mA (IR ON)	708mA Max.
Power Consumption (±10%)	PoE & PoN: 9.5W; DC Adapter: 8.5W (IR On)	PoE & PoN: 10W; DC Adapter: 8.5W
■ Audio		
Line in	YES	
Line out	YES	
■ Others		
Mobile Surveillance	iOS & Android	
Push Video	NO	
Event Notification	FTP / Email / SMS	
Digital Pan / Tilt / Zoom	YES	
Motion Detection	YES	
RTC (real-time clock)	YES	
Minimum Web Browsing Requirements	<ul style="list-style-type: none"> • Intel core i3 or higher, or equivalent AMD • 2GB RAM • AGP graphics card, Direct Draw, 32MB RAM • Windows 7, Vista & XP, DirectX 9.0 or later • Internet Explorer 7.x or later 	

* The specifications are subject to change without notice. ** Dimensional tolerance: ± 5mm

APPENDIX 2 BIT RATE TABLE FOR REFERENCE

The data below is for reference only.

The bit rates listed here may vary depending on the resolution, image quality & frame rate you choose, the complexity of your monitoring area, and how often the moving objects show in your monitoring area.

Testing Environment

- Place: Office Entrance
- Network translation: H.264
- Camera type: Megapixel camera

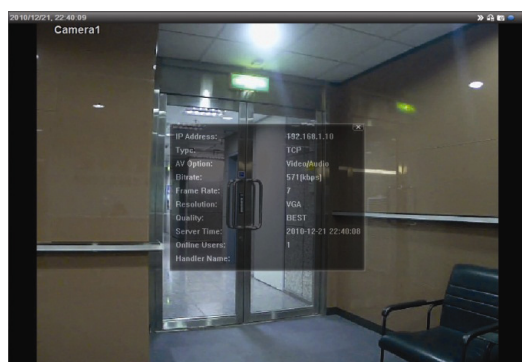

Static: No one coming in and out



Dynamic: One or two people coming in and out

Resolution	Quality	Frame Rate	(Dynamic) kbps	(Static) kbps	
SXGA	Best	FULL	3253	3216	
	High		2375	2160	
	Normal		1571	1266	
	Basic		1465	873	
VGA	Best		2010	1261	
	High		1042	1034	
	Normal		685	572	
	Basic		457	350	
QVGA	Best		646	366	
	High		482	350	
	Normal		302	286	
	Basic		168	161	
SXGA	Best		1/4	1163	1076
	High			989	715
	Normal			855	534
	Basic			719	443
VGA	Best	789		571	
	High	451		447	
	Normal	349		237	
	Basic	217		165	
QVGA	Best	269		147	
	High	182		131	
	Normal	164		113	
	Basic	97		71	

Resolution	Quality	Frame Rate	(Dynamic) kbps	(Static) kbps
SXGA	Best	1/15	581	374
	High		405	342
	Normal		487	248
	Basic		337	141
VGA	Best		358	79
	High		201	63
	Normal		180	28
	Basic		92	15
QVGA	Best		111	84
	High		99	68
	Normal		97	54
	Basic		58	42

APPENDIX 3 POE CONNECTION

This device supports PoE (Power-over-Ethernet), developed by the IEEE802.3af or IEEE802.3at task force, and power can be supplied over the same network (Ethernet) cable as the one used to connect to Internet. No power cable is needed. Below shows two examples of POE application for reference.

- When your router / hub supports POE connection

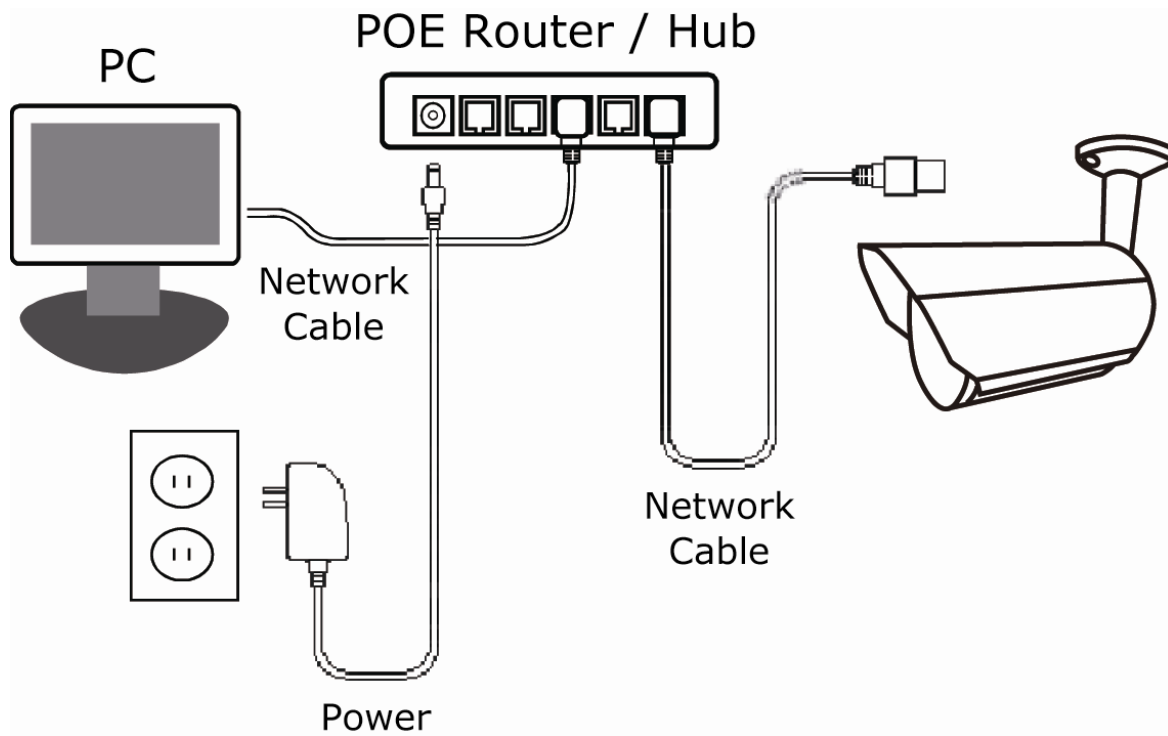

- When your router / hub doesn't support POE connection (An optional POE connector required)

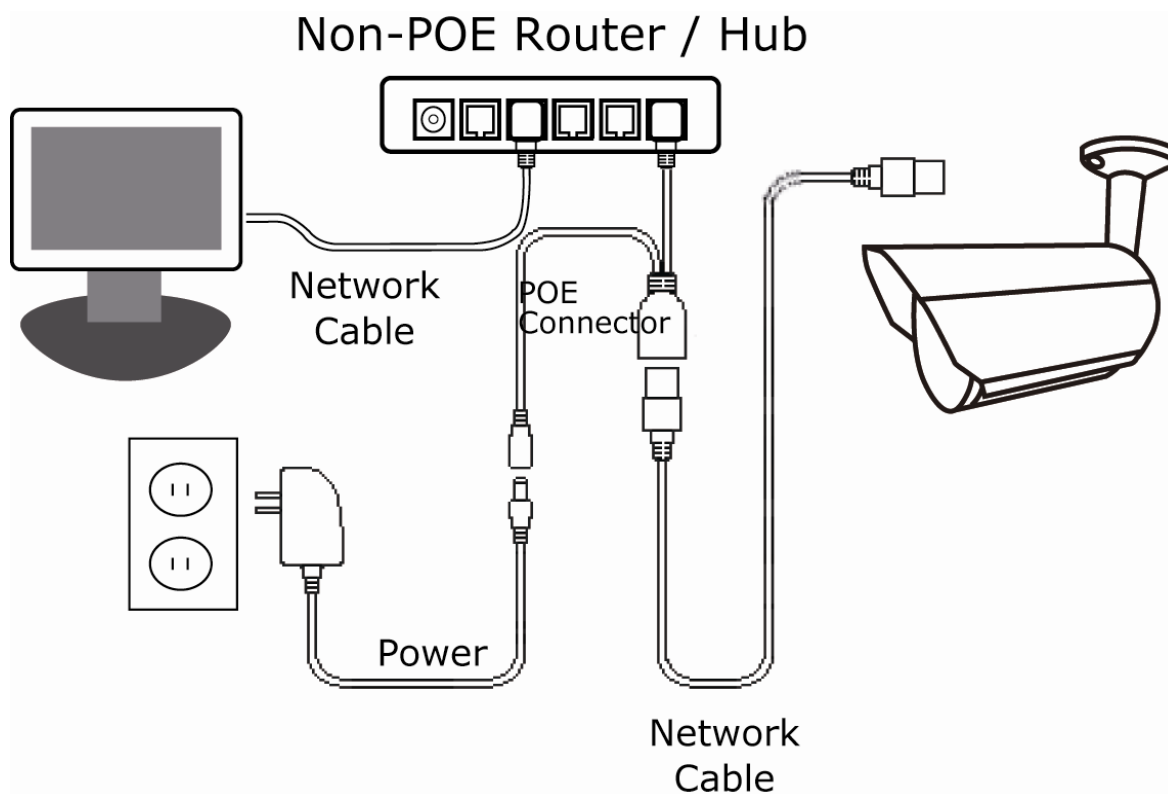

APPENDIX 4 API ID APPLICATION FOR SMS MESSAGING

To allow the camera automatically sending a text message when an event happens, you need to apply an API ID from a mobile messaging company first, such as Clickatell or EVERY8D.

Below shows an example of how to get an API ID from Clickatell.

Note: The SMS messaging may not be totally free. Please check the charge policy of the messaging service you use.

Note: The instructions below are for reference only and may vary when Clickatell's official website is updated.

Please follow the steps below for application.

Step1: Go to <http://www.clickatell.com/login.php>. Sign up an account first.

Login [Click to create an account.](#)
[Don't have an account? Sign up here](#)

Which product would you like to log in to?

- Communicator2**
Send bulk SMS via the internet. No programming needed.
- Developers Central**
Reliable, scalable, customisable. Integrates with your system via APIs.
- Messenger Pro**
Desktop, Bulk SMS solution.
- ICM**
Campaign management for standard and premium-rate marketing campaigns.
- Affiliates**
Advertise Clickatell and increase your earnings with our affiliate program.

Step2: Select “Developers Central”, select the location where you want to use this service, and fill in your information to create an account.

Which product would you like to sign up for?

- Communicator2
Send bulk SMS via the internet. No programming needed.
- Developers Central**
Reliable, scalable, customisable. Integrates with your system via APIs.

Which product is right for me? How much will it cost?

Where would you like to send messages to? **Check which one is suitable for you.**

- International**
excl US Free signup
I want to send fewer than 10,000 messages per month to the Americas
- South Africa
Free signup
- UK
Free signup
- Ireland
Free signup
- India
Free signup

Why special?

What is your first name? *

test

What is your last name? *

test

Which username would you like to use? *

test

What is your mobile number? *

886 22586666

[Country code][area code or network code (without first 0) and mobile number, no space, brackets or dashes]
Example: [1][4155551212](for USA) or [27][123457894](for South Africa)

What is your email address? * [Privacy Policy](#)

test@tech.com

Are you human? *Please enter the words you see in the box, in order and separated by a space.

dynamont This

Type the two words:
dynamont This

noCAPTCHA
reCAPTCHA v3

Create your account

Create my Account By clicking this button, you agree to Clickatell's [Terms and Conditions](#)

Step3: When the account is created, the system will automatically send an Email to your specified Email address with the user name, password, and client ID used to log into the service.

Step4: Click the link within the email to log in, and you will be prompted to validate your mobile phone number. Select “SEND ACTIVATION CODE”. The system will send an activation code to that number for verification.

Check if you receive a text message from Clickatell, and enter the activation code.

Verify your Mobile Number

For security reasons you are required to verify your mobile number in order to make your first credit purchase and send non-test SMS messages.

Your activation code will be sent to

If this is not your number, please retype your mobile number in the box above and click the "SEND ACTIVATION CODE NOW" button.

Enter your activation code once you have received it on your mobile phone:

Coupon Code:

Step4: In your account, find “Connection Status” and create a connection (API ID).

Note: Information on this page may be delayed by up to 1 minute.

<p>Account Status</p> <p>Credit Balance: <input type="text" value="0"/></p> <p>Payments Pending: <input type="text" value="0"/></p> <p>Credit Balance Alert: Disabled</p> <p>Auto Billing: Disabled</p> <p>SMS Bundle: Disabled</p> <p>SenderID: <input type="text" value="OK"/></p> <p>View Daily Volumes</p>	<p>Message Delivery Status MT</p> <p>For period 15 April 2013 between 00:00 and 23:59 (GMT+2)</p> <p>Messages delivered: <input type="text" value="0"/></p> <p>Messages failed: <input type="text" value="0"/></p> <p>Total: <input type="text" value="0"/></p> <p>Click here to view a detailed report.</p>
<p>Connection Status</p> <p>Click here to create a connection (API ID)</p> <p style="text-align: center;">Click here</p>	<p>Message Delivery Status MO</p> <p>For period 15 April 2013 between 00:00 and 23:59 (GMT+2)</p> <p>MO received: <input type="text" value="0"/></p> <p>Click here to view a detailed report.</p>

Step5: Select “HTTP/S”.

Connection Setup

Choose the connection that you would like to add to your account.

HTTP/S **Click “HTTP/S”**

Our most popular connection, HTTP is one of the simpler ways to connect to the Clickatell API. It is used as an HTTP/Internet Post.

SMTP (Email to SMS)

Another firm favourite, the SMTP API allows messages that are sent via e-mail to be converted to SMS. Popular with customers who already have an e-mail messaging system in place.

Give a meaning name for this connection, and click “Submit and Get API ID”.

Add Connection

HTTP API - Information entered during this step can be modified later.

Description: **Give a name for this connection**

Required field

Replace Leading Zero (Dial Prefix)

Enable IP Address Restriction (IP Lock Down)

Enable SMS Status Notification (MT Callback)

Click

Step5: An API ID will be generated as follows.

Note: Note down the API ID for SMS notification setting later.

HTTP API

Your HTTP API connection was created successfully. Your connection is live ready for you to send SMS messages.

API ID used for SMS

API ID:

Description:

APPENDIX 5 Q&A

For more details about Q&A, please visit our official website: www.eagleeyesctv.com

Question	Answer
<p>I can connect to this camera in my house or office where it's installed with wireless network.</p> <p>But when I leave my house or office, I can't connect to it from my mobile phone (with 3G network), or other PC (connected to Internet). Why?</p>	<p>You didn't configure this camera to Internet, but only in LAN.</p> <p>Please follow the steps in the advanced network setup guide downloadable from www.surveillance-download.com/user/m650.swf to complete network configurations, or it's recommended for you to check with your local installer or reseller for this service because it's usually hard for a person who doesn't have network knowledge to set network configurations.</p>
<p>My live images are not fluent. Why?</p>	<p>Image fluency could be affected by the local network upload bandwidth, router efficiency, client network download bandwidth, complexity of live view, and more.</p> <p>(Recommended) To have the best image fluency, select QVGA; to have the best image quality, select "SXVGA" based on the model you have; to have normal image fluency and quality, select "VGA".</p>
<p>The live video keeps flickering. Why?</p>	<p>Please try adjusting the power line frequency to "60 Hz" or "50 Hz" for the camera.</p> <p>For iOS users, access the camera, and select "" on the top right corner to enter IPCAM Configuration page. Then, go to "Advance Setup" → "Camera" to change setting.</p> <p>For access from Internet Explorer, log into the camera, and select "Config." → "Camera" → "Camera".</p>

APPENDIX 6 RECORDING TIME TABLE

Below shows the estimated total recording time for each recording resolution.

The recording time per resolution is the average value collected from the both alarm trigger conditions indicated in “Testing Environment”, and is for reference only.

The time may vary depending on the resolution, image quality & frame rate you choose, the complexity of your monitoring area, and how often the moving objects show in your monitoring area.

Testing Environment

- Place: Office
- Monitoring area: 1.5 meters away from the camera
- Alarm trigger conditions:
 - (1) One person walks by the monitoring area and leaves immediately.
 - (2) Two persons walk by the monitoring area. One goes away immediately, and the other one stays a while and goes away.

Recording Resolution	SXGA	VGA	QVGA
Recording time (second)	25	115	211

APPENDIX 7 PREREQUISITES FOR NETWORK SHARE

“Push Video” is an active notification system, different from traditional FTP & Email notification methods. It’s more active and stable, but also easier to be affected by your network bandwidth.

A7.1 Check PC IP Address

Note: The instructions below are taking Windows 7 and 8 for an example.

Step1: Go to "Network and Sharing Center", and select "Change adapter settings".

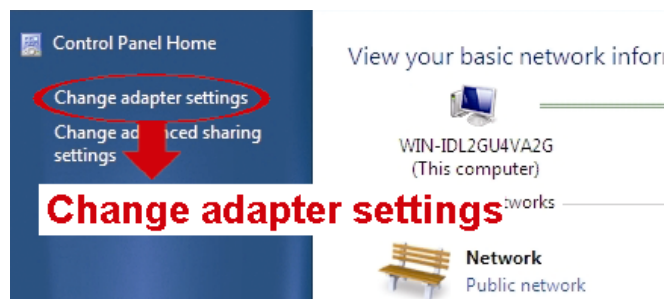

Step2: Right-click on "Local Area Connection", and select "Properties".

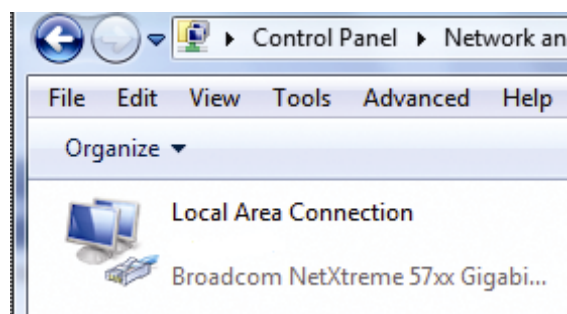

Note: If your local area connection is not enabled, please also enable it.

Step3: In the "Networking" tab, select "Internet Protocol Version 4 (TCP/IPv4)", and select "Properties".

Step4: In the "General" tab, note down the IP address in "Use the following IP address".

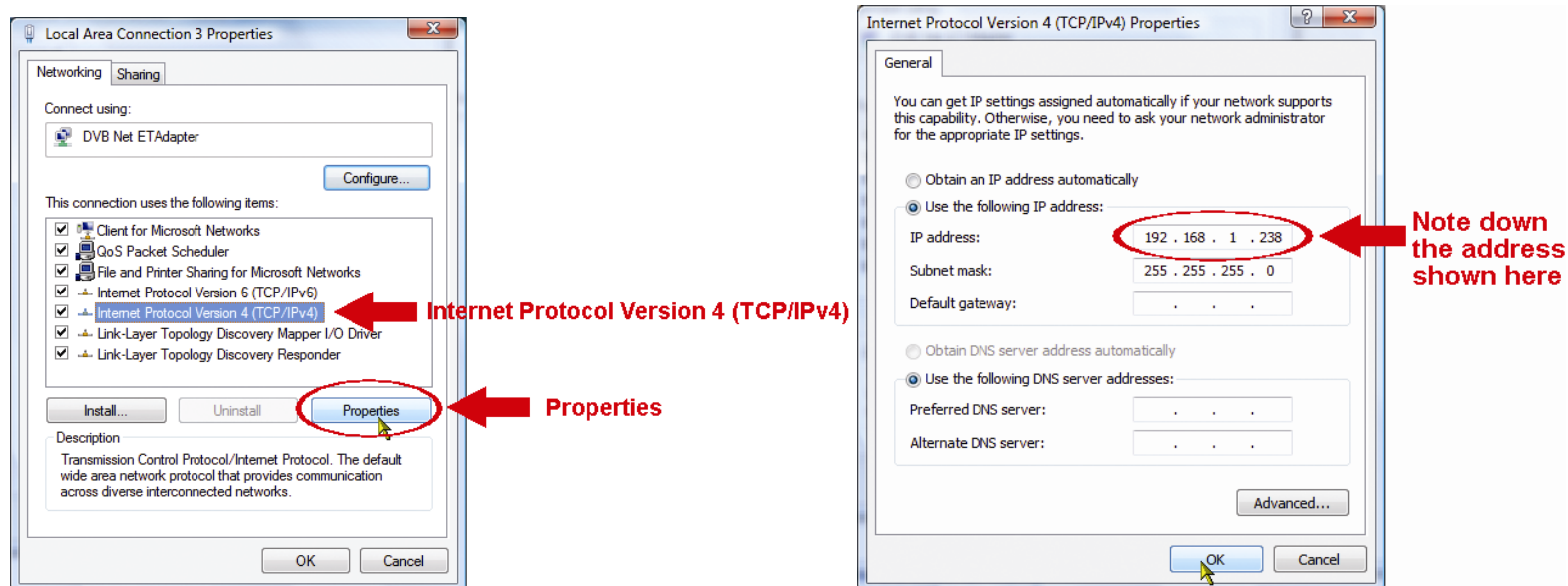

A7.2 Create "Administrator" Account

It’s recommended to create a new administrator account on the PC for “Network Share” to use, or user could use the existing administrator account.

Note: The instructions below are taking Windows 7 and 8 for an example.

Step1: Go to "User Accounts" → "Manage Accounts", and select "Create a new account".

Choose the account you would like to change

EVB
Administrator
Password protected

Administrator
Administrator
Password protected

allen
Administrator
Password protected

Guest
Guest account is off

Create a new account **Create a new account**

What is a user account?

Additional things you can do

Set up Parental Controls

Go to the main User Accounts page

Step2: Set a user name, and choose “Administrator” for this account. Then, click “Create Account”.

Name the account and choose an account type

This name will appear on the Welcome screen and on the Start menu.

Office

- Standard user
Standard account users can use most software and change system settings that do not affect other users or the security of the computer.
- Administrator
Administrators have complete access to the computer and can make any desired changes. Based on notification settings, administrators may be asked to provide their password or confirmation before making changes that affect other users.

We recommend that you protect every account with a strong password.

Why is a standard account recommended?

Create Account

Cancel

Step3: Set the password, and click “Create Account”.

Create a password for Office's account

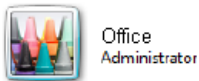

Office
Administrator

You are creating a password for Office.

If you do this, Office will lose all EFS-encrypted files, personal certificates and stored passwords for Web sites or network resources.

To avoid losing data in the future, ask Office to make a password reset floppy disk.

••••

If the password contains capital letters, they must be typed the same way every time.

[How to create a strong password](#)

Type a password hint

The password hint will be visible to everyone who uses this computer.

[What is a password hint?](#)

Create password

Cancel

A7.3 Share Folder

Note: The instructions below are taking Windows 7 and 8 for an example.

Step1: Right-click the folder you want to use to save snapshots for “Network Share”, and choose “Properties”.

Step2: In “Share Properties”, select the tab of “Sharing”, and choose “Share...”.

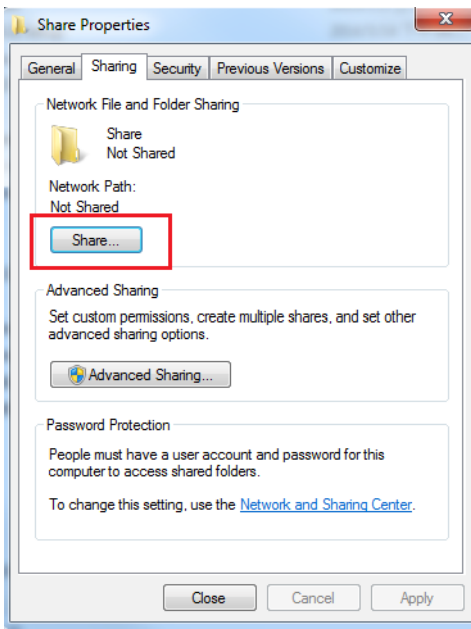

Step3: Choose the account you want to share with, and click “Share” to save.

